

Loudspeaker phase measurements transient response and audible quality

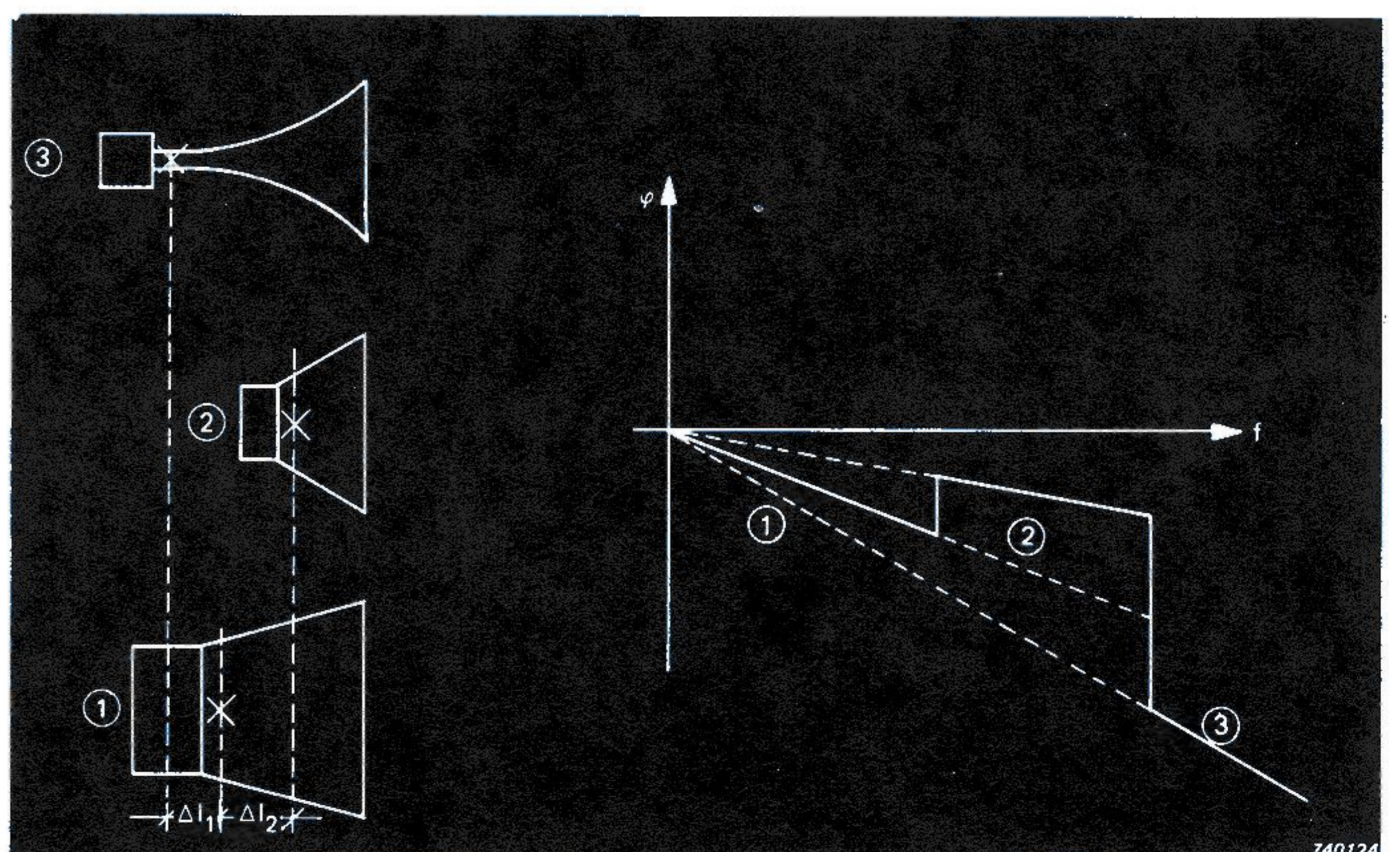
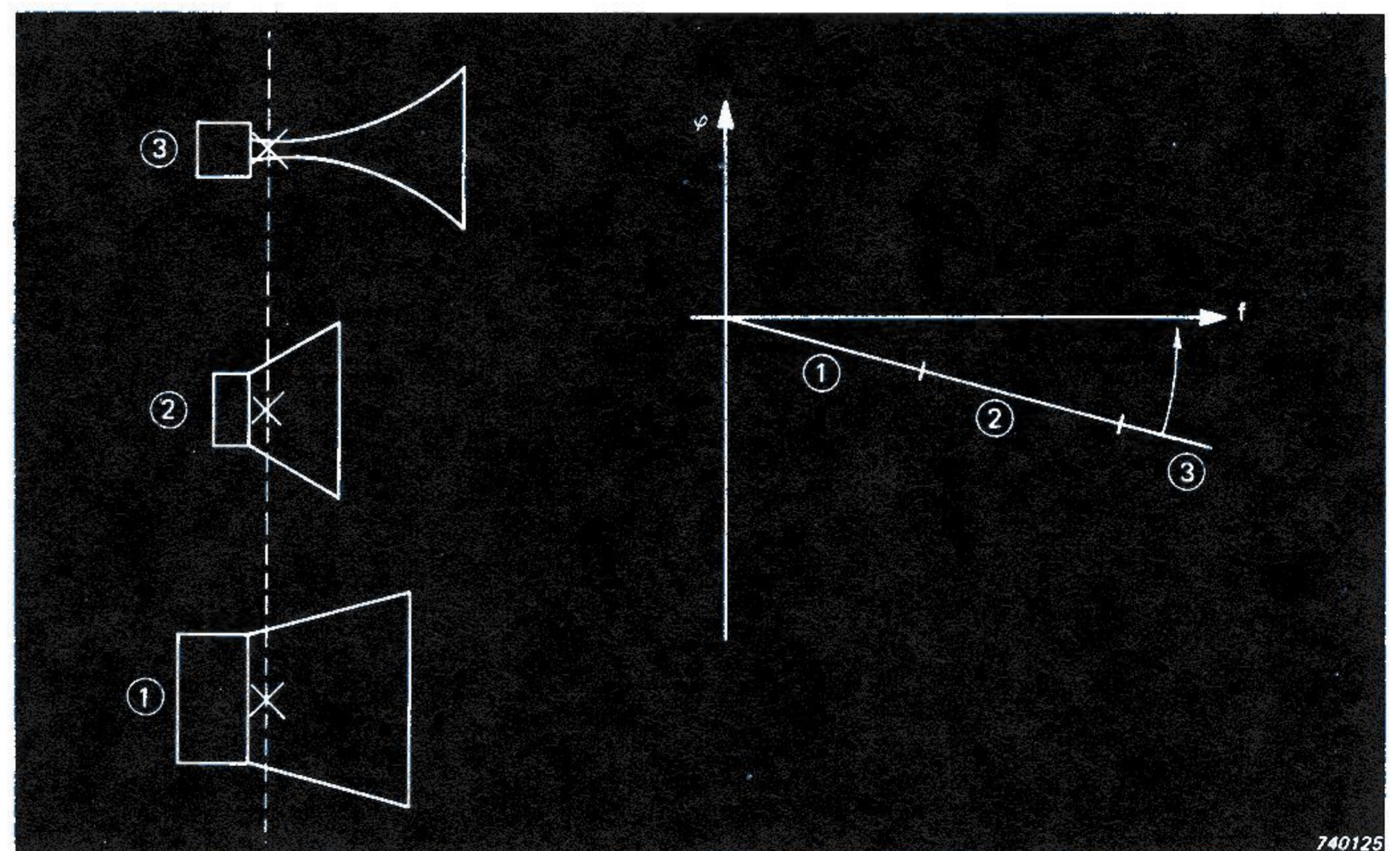
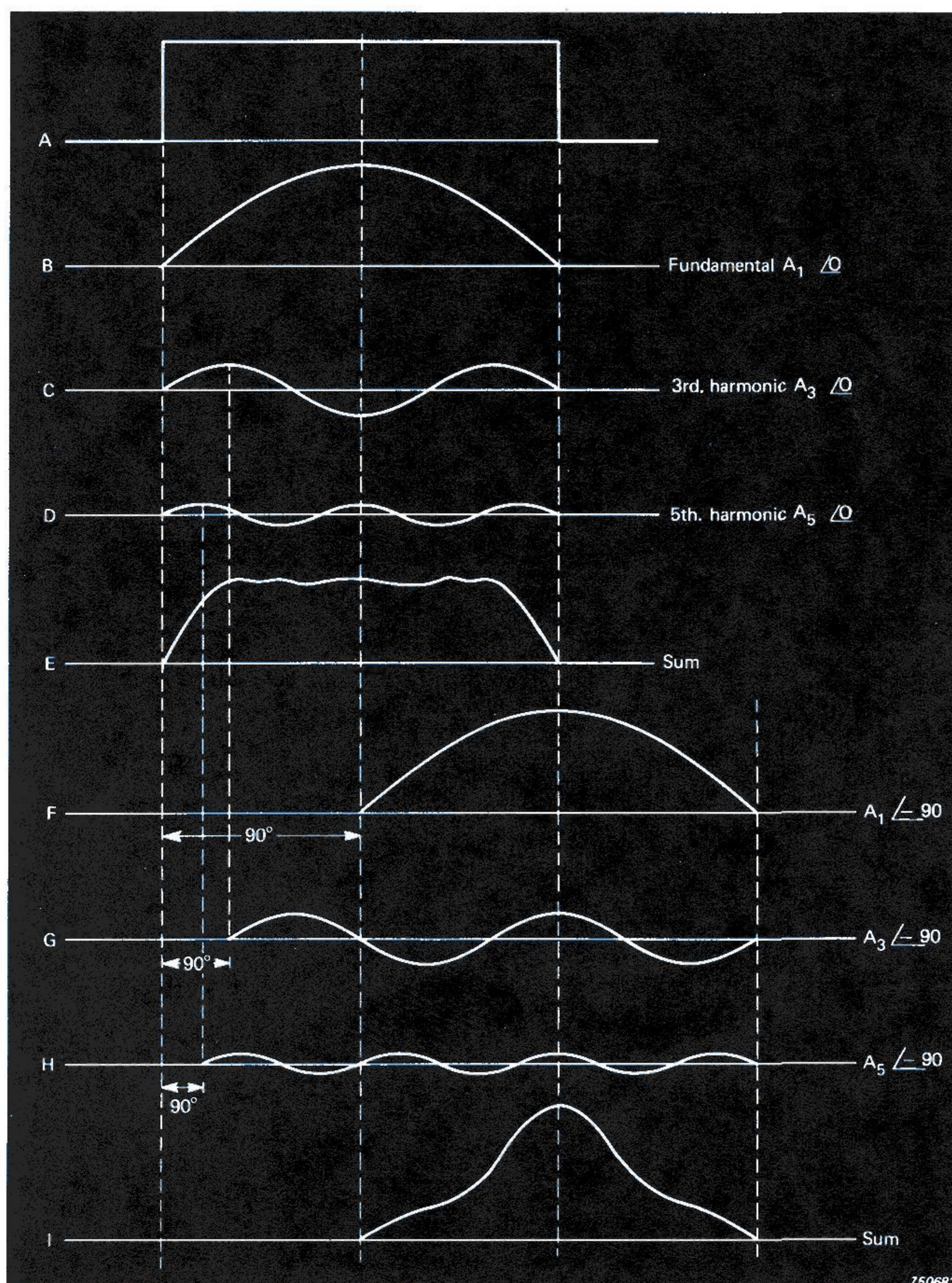

Expanded version of the original paper presented at
the 48th Audio Engineering Society Convention California, USA

Loudspeaker phase measurements, transient response and audible quality

By Henning Møller, Brüel & Kjær

Abstract

The transient response of a complex loudspeaker system can often be improved simply by repositioning the speakers. How much axial movement is required will be indicated by studying the phase response of the system.

The phase response $\Phi(s)$ together with the amplitude response $A(s)$ gives the complete transfer function $H(s) = A(s) e^{j\Phi(s)}$ which describes the steady state and transient responses of the system.

This note will show that with the Phase Meter 2971 and Phase Delay Unit 6202, a new technique has been introduced to make swept phase measurements as easy as swept amplitude measurements.

It will be shown later that loudspeakers are not necessarily minimum phase systems and therefore that the phase response can not be calculated from the amplitude response, it must be measured separately.

Phase measurements are made primarily to obtain information about the transient response.

Traditionally, one has concentrated only on the amplitude response and ignored the phase response. The reason may have been the practical problems involved in

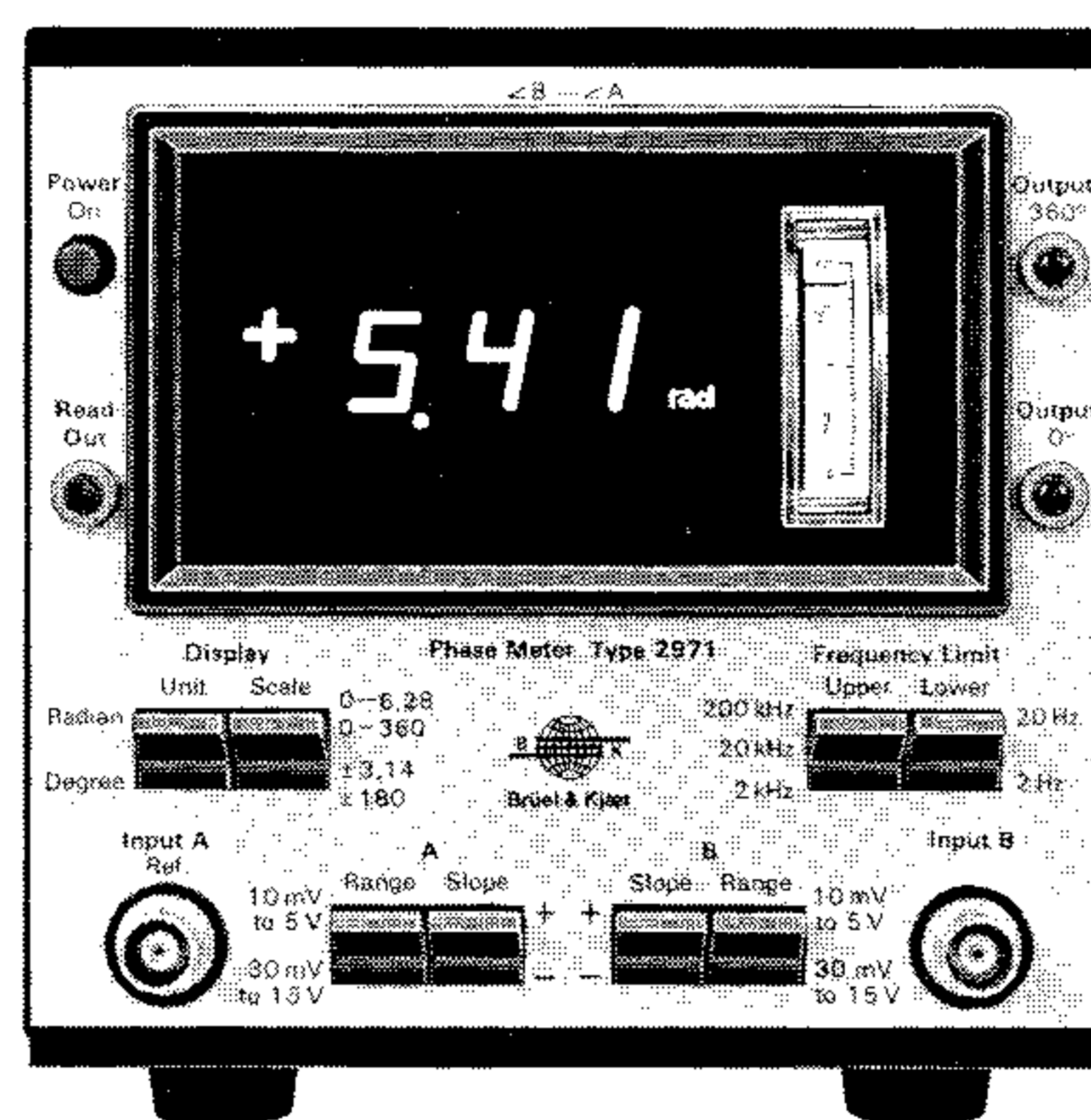

2971

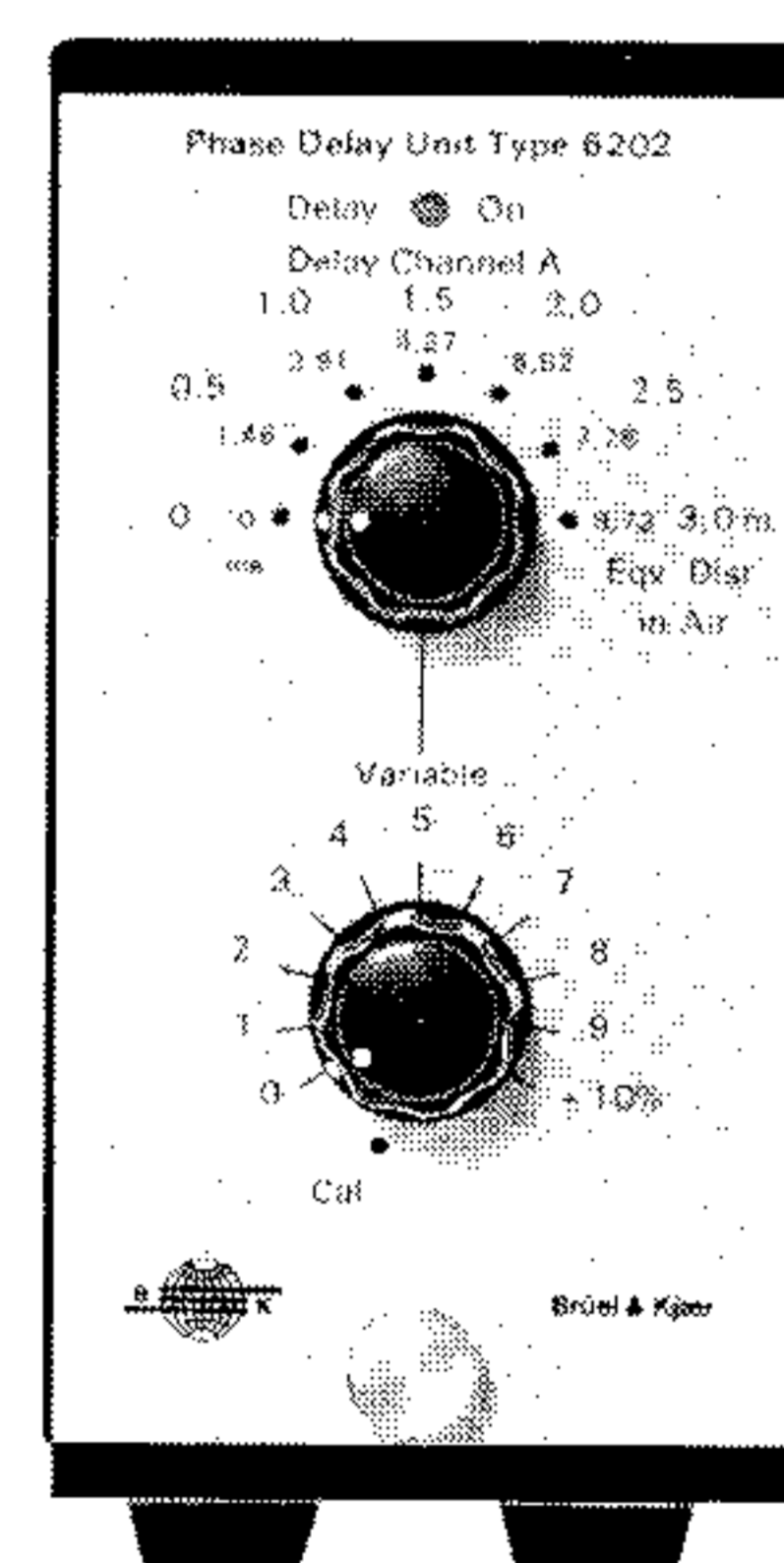

6202

making loudspeaker phase response measurements. — Techniques using tone bursts or fast Fourier Transform have until now provided the only possibilities.

It is known from Fourier analysis that a transient can be seen as a combination of an infinite number of sine waves. A swept phase measurement of the response of a loudspeaker system to a transient will indicate if the time relation between these sine waves is correct and whether they will recombine to result in an acoustic waveform identical to the original transient.

A poor phase response has no influence on the reproduction of pure sines; nor on steady state music, such as a sustained chord from an organ. But it shows up in transients, such as booms from kettle-

drums, or bass drums pizzicato from strings, short blasts from horns, attack on piano and guitar and the clash of snare drums, cymbals and triangles.

This Application Note will concentrate primarily on phase response in relation to transient response, but will also consider subjects such as minimum and nonminimum phase behaviour and phase responses of conventional types of loudspeaker cabinets and microphones. It will interpret phase response curves and give practical examples.

Why Measure Phase Response?

Phase distortion and time distortion are often the same thing, as shown in Fig.1. — In the frequency domain phase is angular shift, in the time domain; it is time shift.

This consideration is extremely fundamental in understanding the significance of phase response.

However, phase shift can occur without a corresponding time shift, for instance 180° in an inverter for all frequencies in a given range.

As an example of time-related phase distortion, consider again the boom from a kettledrum with all its different frequencies. The correct reproduction of such a signal requires that all the spectral components in the signal are reproduced with their correct amplitude and time relationships.

If the amplitude response curve of the loudspeaker is linear, then the relationship between the high and low frequency amplitudes will be correct; also, if the phase response curve is linear, then the low and high frequencies will reach the ear in their correct time order.

In the concert hall, this will always be the case, since, fortunately, the velocity of sound is independent of frequency. If now the signal is to be reproduced by a loudspeaker system, then the latter will normally introduce frequency-dependent phase shifts. Frequency components with large negative phase shifts will arrive at the listener's ear later than those with small phase shifts; the result is a signal distorted in the time domain. This is particularly critical when the original signal contains transients.

As mentioned earlier, a single transient can be seen as a combination of an infinite number of sine waves. This is a little inconvenient to illustrate on a drawing and therefore a "continuous transient" — that is a series of transients forming a square wave — is used in Fig.2, which shows that a square wave can be regarded as a combination of a fundamental sine wave and a number of harmonic components.

If the fundamental, 3rd and 5th harmonics only (B, C and D) are combined in phase, the sum (E) is a reasonable approximation to the ideal square wave (A), but if, for instance, all the components are shifted 90° in a system, the combi-

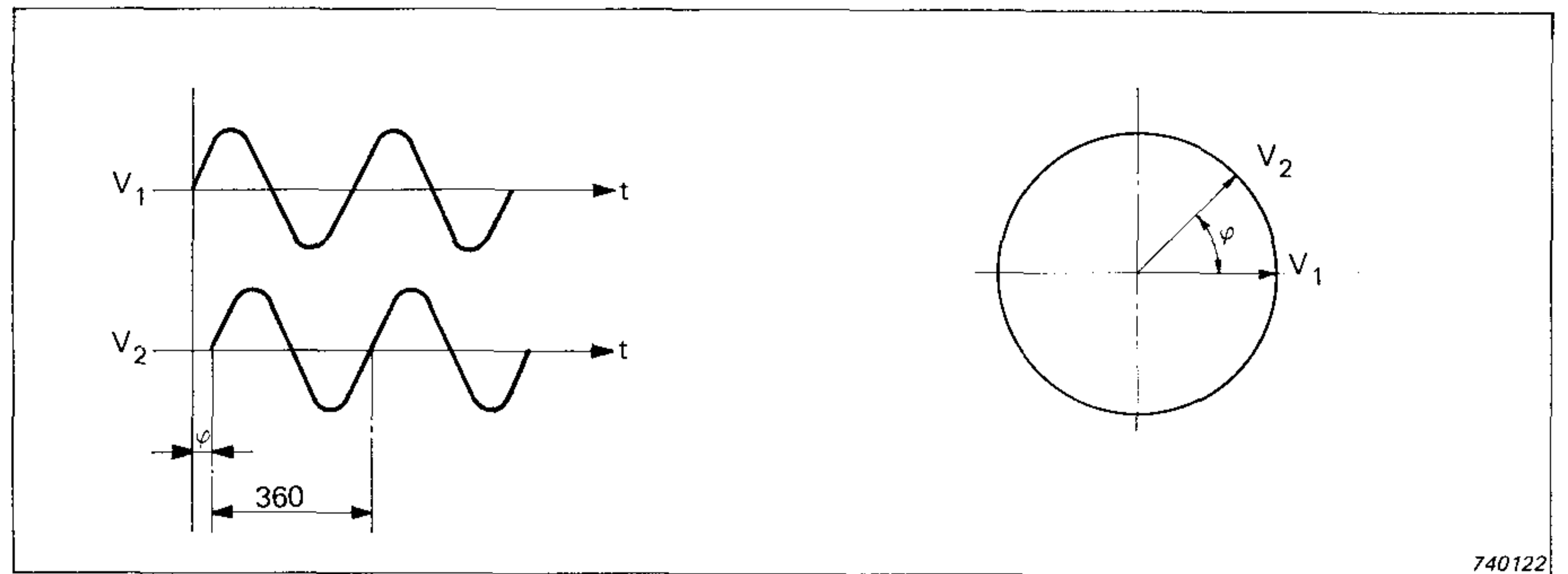

Fig. 1. Relationship between time delay and phase shift

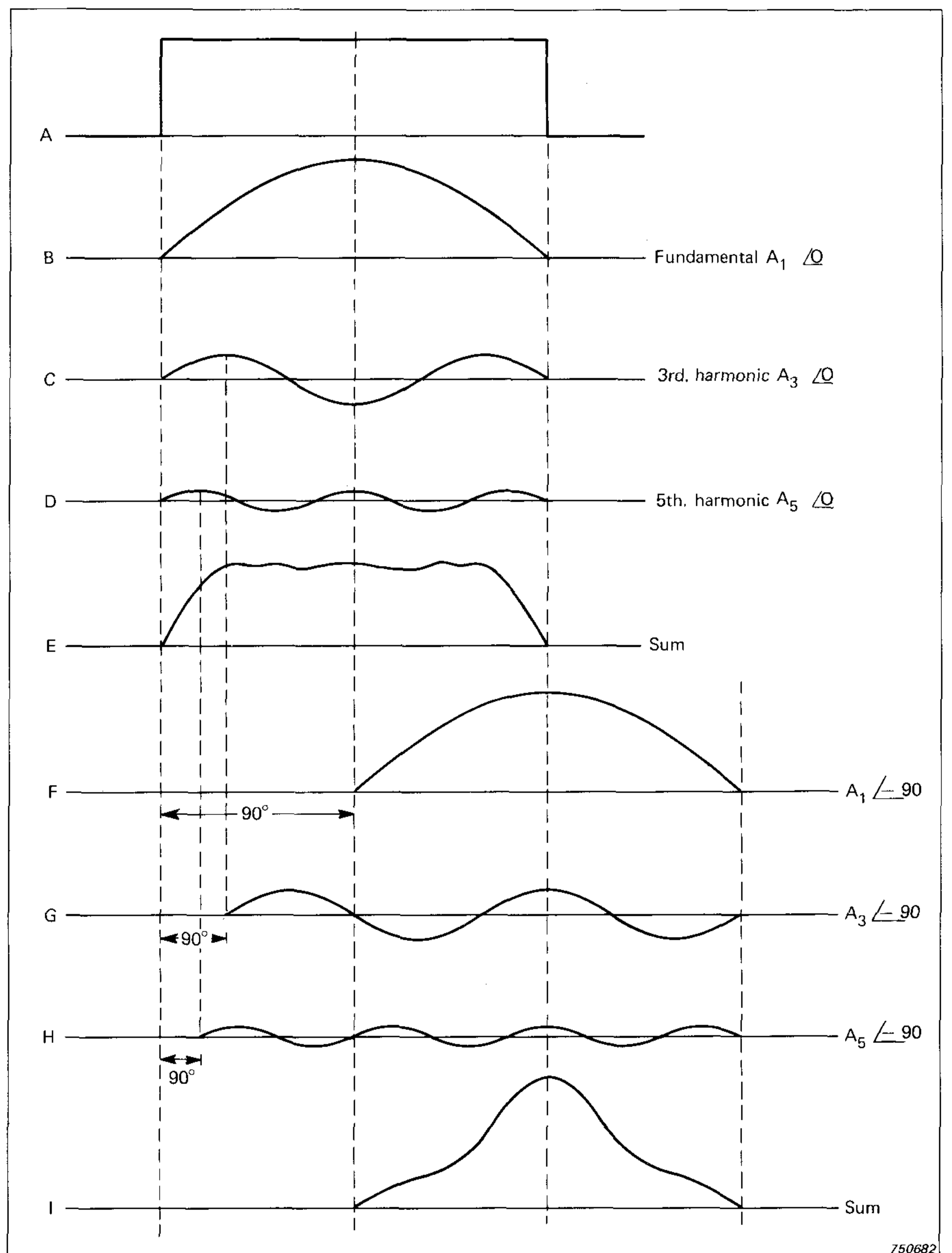

Fig. 2. A "continuous transient" a square wave consists of a fundamental sine wave and a number of harmonic components. When in phase (B-D) these can recombine (E) almost as the original signal (A). When shifted 90° (F-H) the recombined signal (I) is very different from the original. Good transient response requires that the components are in phase

nation F, G and H will have a sum (I) which is shifted 90° in time, but with a waveform very different from the ideal square wave (A), and therefore the system will have a poor transient response.

This simple example indicates the importance of swept phase measurements as they make it possible to read the relative phase shifts between different frequencies and therefore also between a fundamen-

tal and its harmonics. Unfortunately such frequency dependent phase shifts often appear in practice. For instance, the bass and midrange speakers in a complex loudspeaker system might cause differential phase shifts which, in the time domain, mean that the low and mid frequency components will not reach the ear in their correct relative sequence. If the boom from the kettledrum is considered under such a situation, it results in a coloration of the reproduced signal — too boomy if the bass arrives first at the ear; and too sharp if the mid frequencies arrive first.

As indicated in the practical example later, the cause of the phase shift might simply be the physical distance between the acoustic centers of the bass and midrange speakers. In this case steps for improvement seem fairly simple — the speakers must be axially repositioned, by how much will be indicated by their phase responses.

Unfortunately, it is not always as straight forward as this in practice, since it happens that the location of the acoustic centre is frequency dependent, and that individual speakers have variable phase shifting characteristics which are also functions of frequency. Later, we shall see some examples.

It is often said that axially repositioning loudspeakers could not have much influence since relative repositioning of instruments in an orchestra is known not to be important, at least not as far as transients are concerned.

However, there is a big difference between these two cases. If an instrument is repositioned, then it is the entire instrument where both the low and high frequency components from the instrument are moved. In the loudspeaker case, repositioning means that low and high frequency components from **one** instrument are shifted relative to each other and this creates time distortion; or transient distortion.

This physical phenomenon is also an important reason why the multi-channel microphone recording technique is useful. If each microphone has a perfect amplitude and phase

response and only picks up the sound from one instrument, the recorded result will be perfect with respect to transients. However, if the outputs from two microphones, placed at different distances from the instrument, are mixed together, the recorded result will be worse than if only one perfect microphone was used. This is also one of the reasons why recording engineers use either a multitude of very close-up microphones or very few far microphones. Of course the mixing possibilities available using multi channel recording techniques should not be overlooked.

These problems detract from the original subject of phase response of loudspeakers slightly but they indicate that phase is important with regard to all electroacoustic transducers. The entire chain involved in audible quality should be perfect. Microphones, mixers, shapers, tape recorders, cutting machine, pickups, preamplifiers, power amplifiers and of course loudspeakers.

Relevance of Free-Field Phase Measurements

It is known that the free-field, on axis amplitude response can only be used as a start to loudspeaker development — it doesn't give sufficient information about the speaker.

Power characteristics, 1/3 octave measurements in the actual environment (Ref. 4) and directional characteristics give much more information about the system. Why then should phase measurements measured in a free-field have anything to do with the sound picture in the actual listening room. The answer is, that a straight phase characteristic together with a straight amplitude characteristic implies a perfect impulse response, which is particu-

larly important because the ear mainly perceives the front edge of the pulse. Thus, considering impulses, it is the first part of the signal which has the main influence. Now the part that arrives first at the ear in the actual room is the part which is transmitted directly, and it is exactly this part which is measured in the anechoic chamber. In this way, phase measurements made in anechoic chambers seem relevant to Hi-Fi sets used in normal listening rooms.

Measuring Set-Ups

With the introduction of the Brüel & Kjær Phase Meter 2971 and the Phase Delay Unit 6202 it is as easy to measure the phase response of a speaker as it is to measure its amplitude response.

The classic set-up for measuring amplitude response is shown in Fig.3, and the corresponding set-up for measuring phase response is shown in Fig.4. Typical amplitude and phase response curves are shown in Figs.5 and 6.

In both cases a sinusoidal signal is applied to the loudspeaker and the reproduced signal is measured with a condenser microphone and measuring amplifier.

Since the microphone is necessarily located apart from the speaker, there will be a time delay from when the signal leaves the speaker to when it reaches the microphone. This time delay will correspond, as we saw earlier, with a phase shift, therefore, a direct measurement cannot be made. Moreover, the time delay will cause an increasing phase shift with increasing frequency. At high frequencies, the separating distance between microphone and speaker will cause a phase shift of several times 360° .

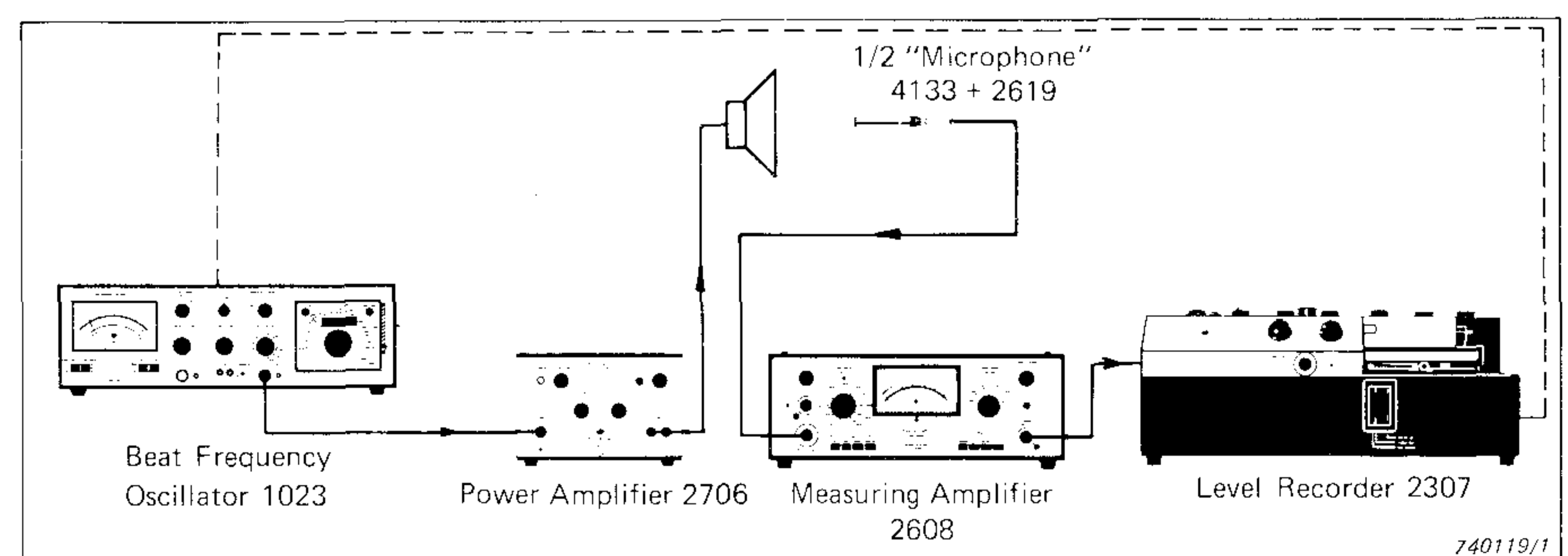

Fig.3. Instrument set-up for amplitude measurements

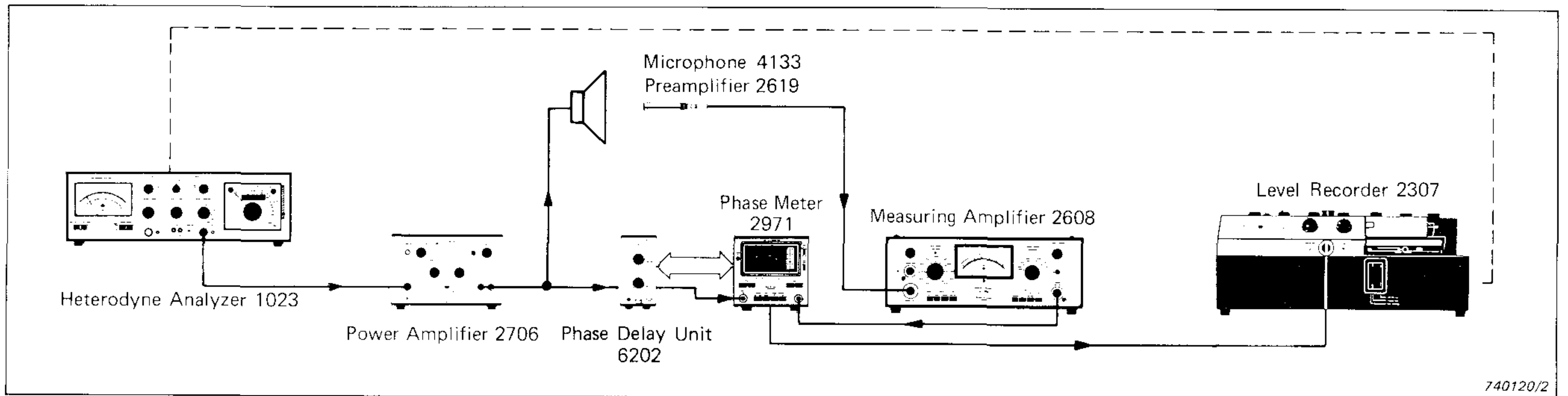

Fig.4. Instrument set-up for phase measurements

A measuring distance of 1 m will cause a phase shift of $360/17 \cong 21^\circ$ at 20 Hz and $360/0,017 \cong 21000^\circ \cong 59 \times 360^\circ$ at 20 kHz.

This problem is overcome, as shown in Fig.4, by placing the Phase Delay Unit 6202 in the reference channel. The delay unit is independent of frequency and will delay the signal from the power amplifier to the Phase Meter by the amount of time it takes the signal to travel from the speaker to the microphone.

In operation, the Phase Delay Unit is digital, as will be shown later, and it is fed from a 7-pin socket on the back panel of the Phase Meter.

The delay unit is calibrated in meters and can be adjusted according to the selected measuring distance between speaker and microphone. The settings are: 0,5; 1; 1,5; 2,0; 2,5; and 3,0 m, and each can be varied continuously up to 10%.

With the Phase Delay Unit in circuit, the Phase Meter Type 2971 shows the phase difference between the delayed signal and the signal from the microphone. The result is read out on a 3 digit display in degrees or in radians in the range 0 to 360° or $\pm 180^\circ$. Further, the result is available from a rear panel socket as a DC voltage which is proportional to phase. This output, as shown, is led to a level recorder, so that while the generator is sweeping, the response of the speaker will automatically be plotted out on the level recorder.

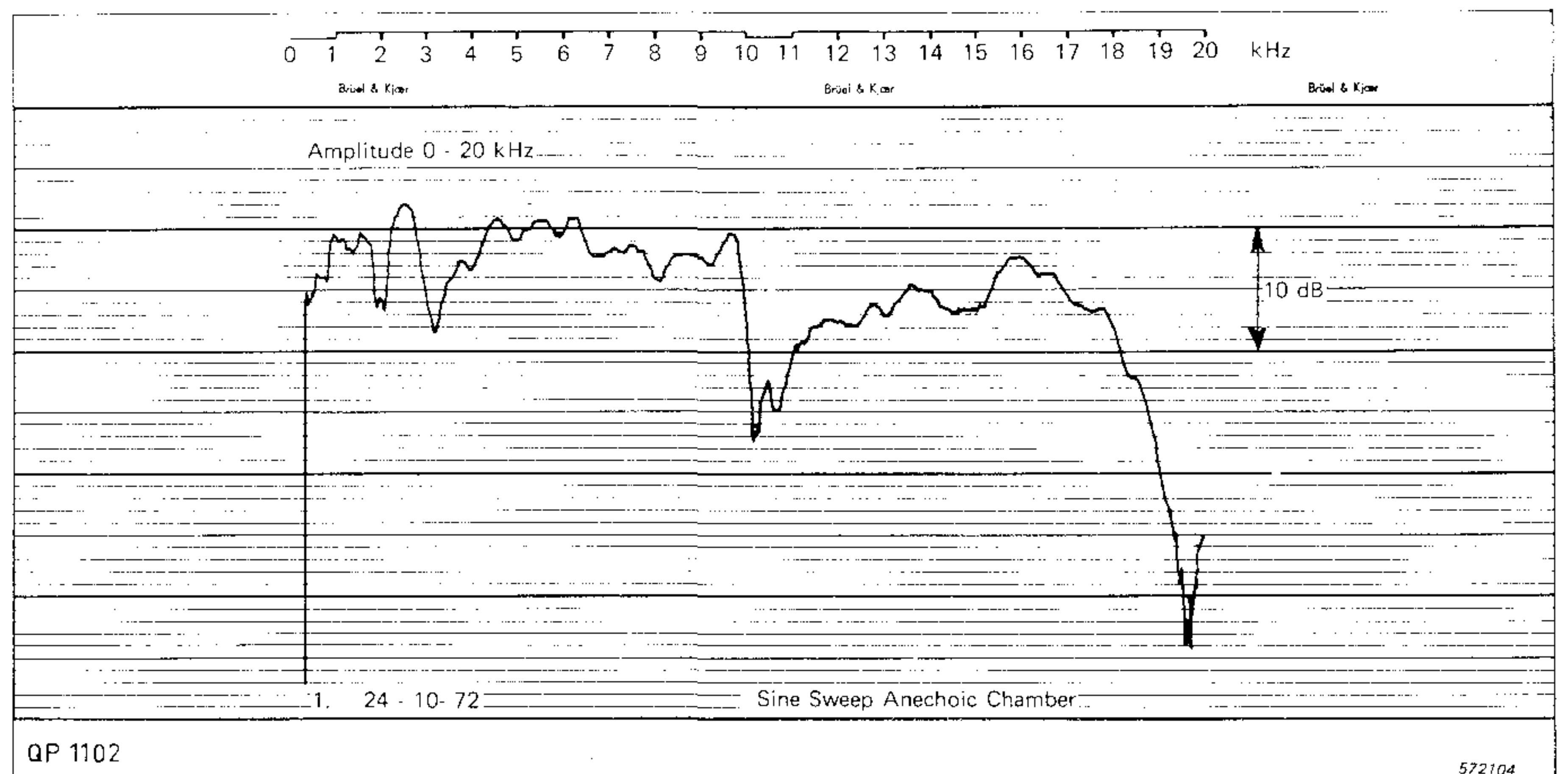

Fig.5. Typical amplitude response curve

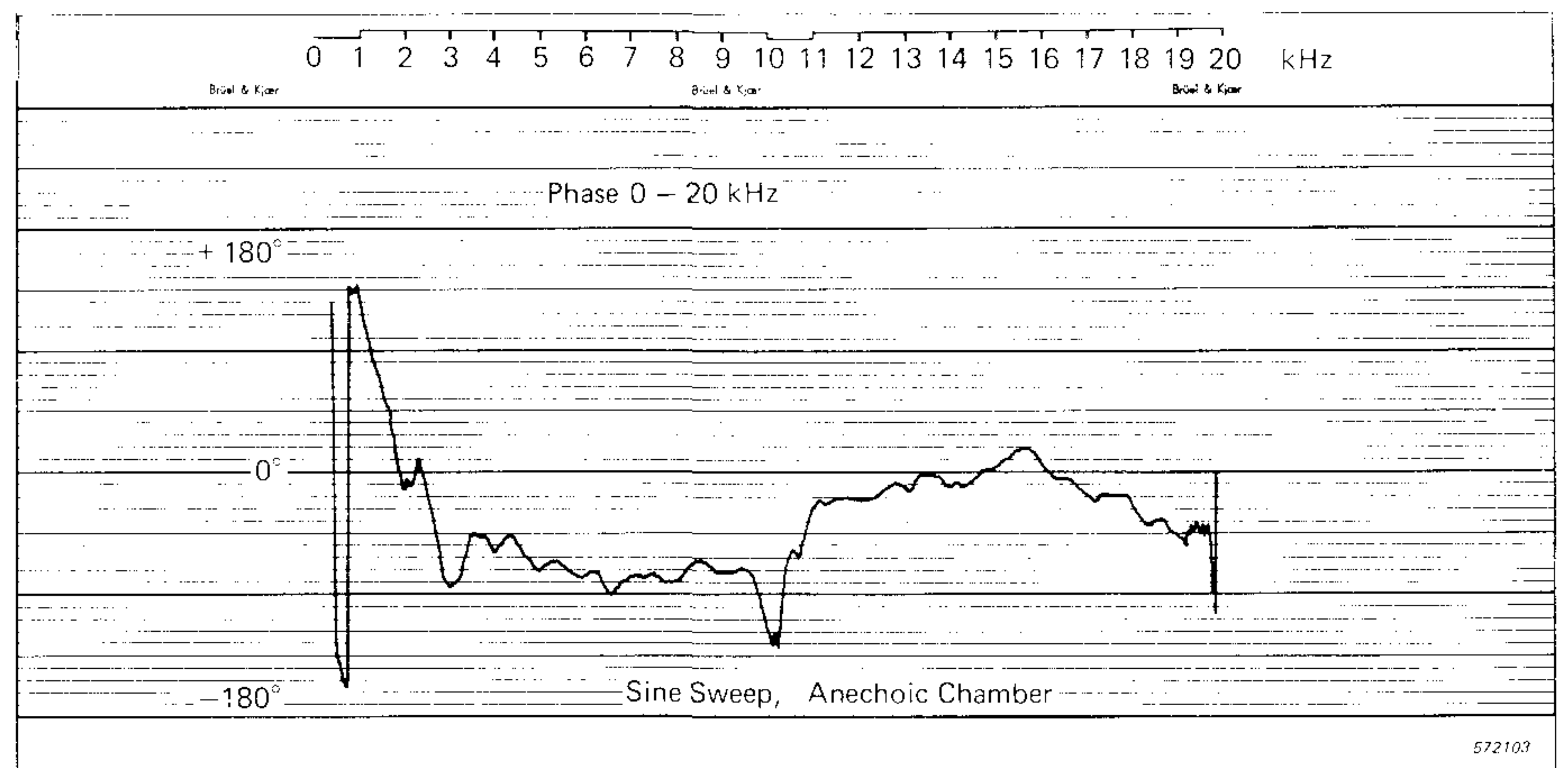

Fig.6. Typical phase response curve

The Principle of Operation Adopted in the Phase Meter and the Phase Delay Unit

Phase Meter

A simplified block diagram is shown in Fig.7. The two signals (A and B) are led to two Schmitt triggers, and the resulting square waves (A' and B') are led to a flip-flop which is set when $A' = 1$ and reset when $B' = 1$. The pulse width of the output signal from the flip-flop (C) is directly proportional to the phase shift between the two input signals. The above-mentioned

DC-voltage is the average of this signal. In practice the average of C is made by a 4th order Bessel lowpass filter.

The slope switches on the Phase Meter make it possible to measure the phase difference between any combination of the positive- and negative-going slopes of the two sine wave signals. This is made possible by introducing inverters at points A' and B' which give a 180° phase shift by changing 1 to 0 and vice versa.

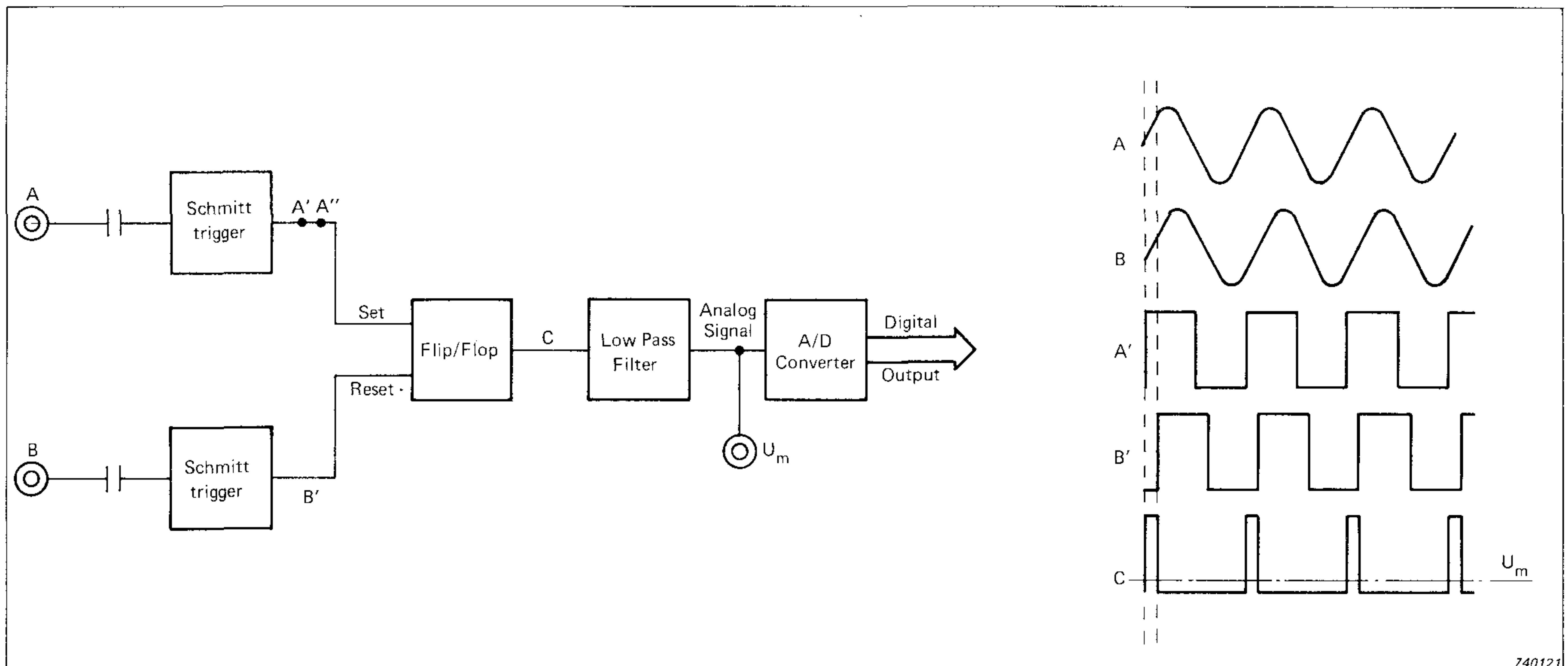

Fig. 7. Simplified block diagram of the Phase Meter 2971

This feature gives greater stability of measurements around 0° and it makes it possible to obtain correct measurements on asymmetric signals with duty cycles different from 50%.

For calibration, a 360° push button can be activated. The Phase Meter then goes to 360° and gives a DC voltage of 3,6V at the output. This is used for adjusting the pen of the Level Recorder to the top line of the recording paper. When the 0° push button is activated, the Level Recorder should go to the bottom line of the paper. If it does not, the DC offset potentiometer on the rear of the Phase Meter must be adjusted.

To position the zero degree phase shift line in the middle of the paper, one of the slope switches can be used. In practice, this is very useful as will be seen later, Figs.15 and 16.

Phase Delay Unit

A simplified block diagram of the Phase Delay Unit is shown in Fig.8. It consists basically of three sections: six, 1024 bit shift registers, a variable clock generator and a separate analog filter for compensation of the phase characteristics of the Heterodyne Slave Filter 2020, when this instrument is used with the Delay Unit. Connection to the Phase Meter is made by an AQ 0042 cable, by way of a standard, 7 pin DIN socket, which feeds the digital information from the Phase Meter

to the Phase Delay Unit and back again and also supplies the necessary power to the Unit. The output of the Schmitt Trigger (A') is in digital form and is fed via the cable through the Phase Delay Unit and then back to the Phase Meter as signal A''.

The outputs of the shift registers correspond to the fixed delay positions of 0,5m to 3,0m on the Phase Delay Unit and the corresponding 10% variation facility is obtained by varying the clock frequency in the range 704 kHz to 633 kHz.

It should also be mentioned that the Phase Delay Unit can not be used separately as an analog delay line, it can only operate together with the Phase Meter. It doesn't need A/D and D/A converters

since it operates with a signal which has already been digitized (one bit) in the Phase Meter.

In order to obtain an accurate delay, the input square wave must be sampled at a high rate to precisely determine the moment that the square wave shifts from 0 to 1. To obtain 1° accuracy it would imply that the clock frequency must be 360 times the input frequency. However, in practice, this is not necessary and a much lower frequency can be used, even though this may cause some sampling uncertainty or jitter. This is because the jitter will be averaged out in the low pass filter of the Phase Meter, thus still giving a correct result (Fig.7).

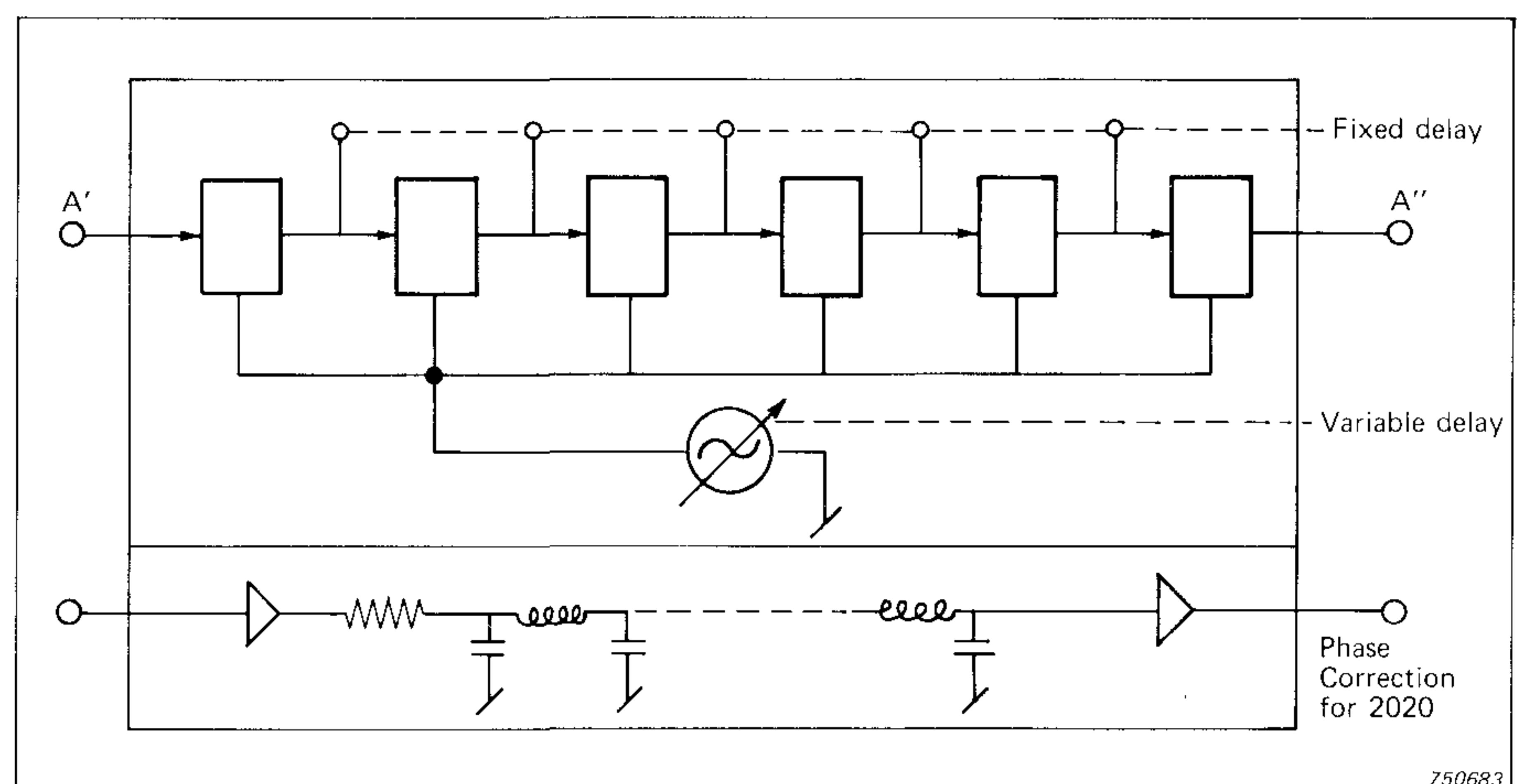

Fig. 8. Simplified block diagram of the Phase Delay Unit 6202

This feature is quite important when the Phase Delay Unit is used with an external clock generator for obtaining longer delay times and may then be used with reasonable accuracy up to around 200 ms delay. The accuracy can be seen from Fig.9. This may be useful for tape recorder measurements where the distance between recording head and play back head gives exactly the same delay problems as that of microphone-loudspeaker distance.

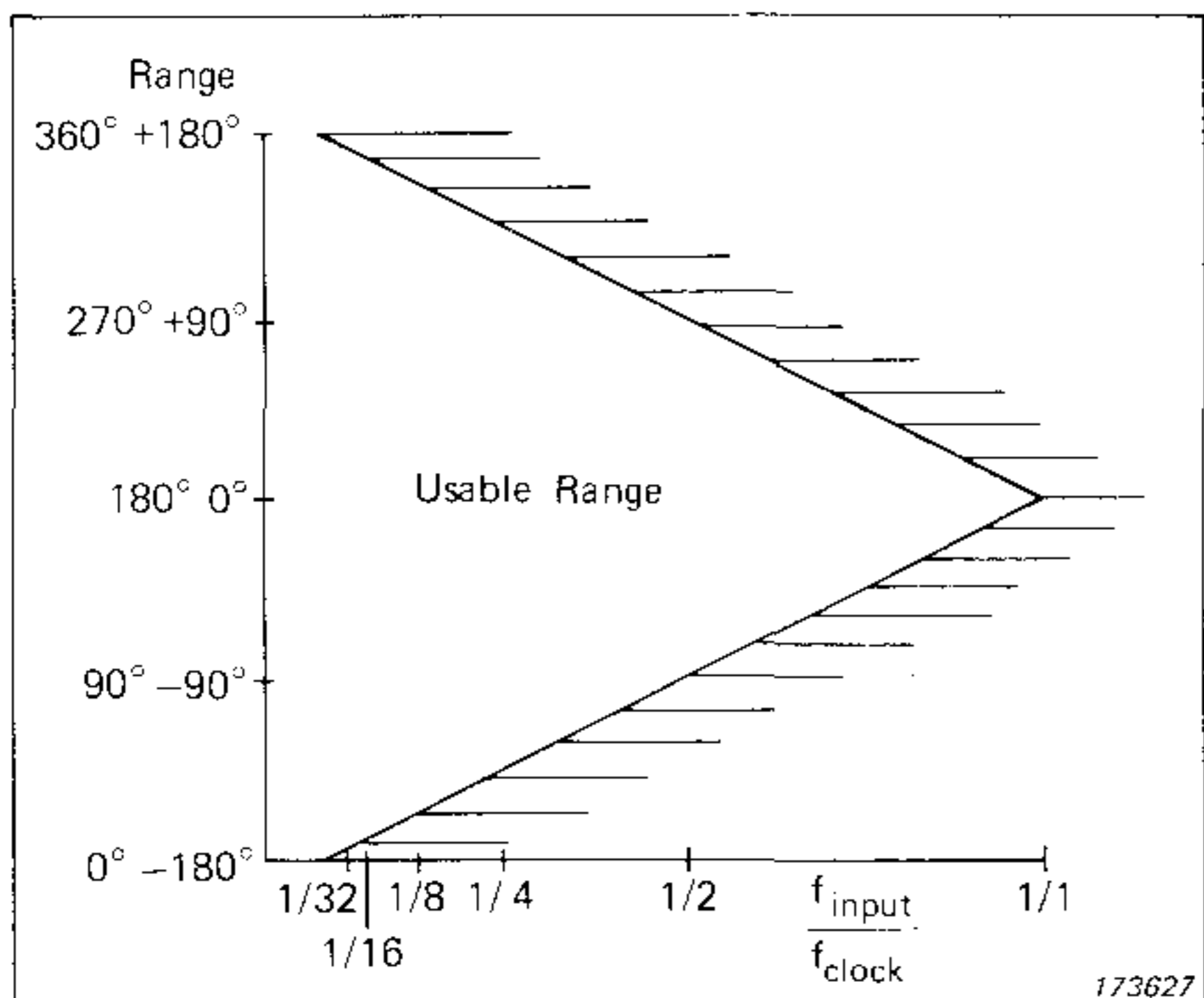

Fig.9. Usable range for phase measurements for different ratios between input frequency and clock frequency

For measurements on tape recorders, the clock frequency must be precisely adjusted as indicated in Figs.10 and 11. The difference between the two curves is due to a clock frequency difference of 10 Hz at 35333 Hz, a difference of only 0,03%. An increasing instability is also noted at higher frequencies. This is due to wow and flutter of the tape recorder but can be averaged out by use of a longer time constant such as provided in the 2 Hz position of the Phase Meter.

The analog filter for phase compensation with the Heterodyne Slave Filter 2020 is only used when a 2020 is used in the measuring channel. The compensation is made by introducing the same filter into the reference channel as the 2020 introduces into the measuring channel. Perfect compensation can be obtained by running an electrical test sweep of the measuring equipment itself and adjusting two small potentiometers inside the Phase Delay Unit, one for 20 Hz and the other for 20 kHz. The only item in the chain which is not calibrated by this procedure is the microphone. However, the half inch Condenser Microphone Type 4133 is phase linear within 5° in the range 20 Hz to 20 kHz.

Interpretation of Phase Response Curves

Amplitude response curves are well known. Here it is the shape of the curve which is important while it does not matter if the whole curve is for instance, shifted 10 dB higher or lower as long as it does not go down into noise or up into distortion.

Interpretation of phase response curves, however, is somewhat different, and cannot be viewed in the same manner as an amplitude response curve.

Practical examples of corresponding amplitude and phase response curves are shown in the range 0 to 2 kHz in Fig.12 and in the range 0 to 20 kHz in Fig.13. These curves are taken from Staffeldts "Højtalerundersøgelse" (Ref.3).

The first thing to note from these curves is the linear frequency scales. The linear y-scale made using a linear potentiometer ZR 0002 in the Level Recorder doesn't seem surprising, but the linear x-scale may seem a little unusual.

On amplitude response curves, logarithmic scales are almost always used simply because the ear responds logarithmically to frequency changes, and although logarithmic phase response curves could be drawn as easily as amplitude response curves, they are often difficult to interpret. Greater ease of interpretation is the only reason for linear phase response curves.

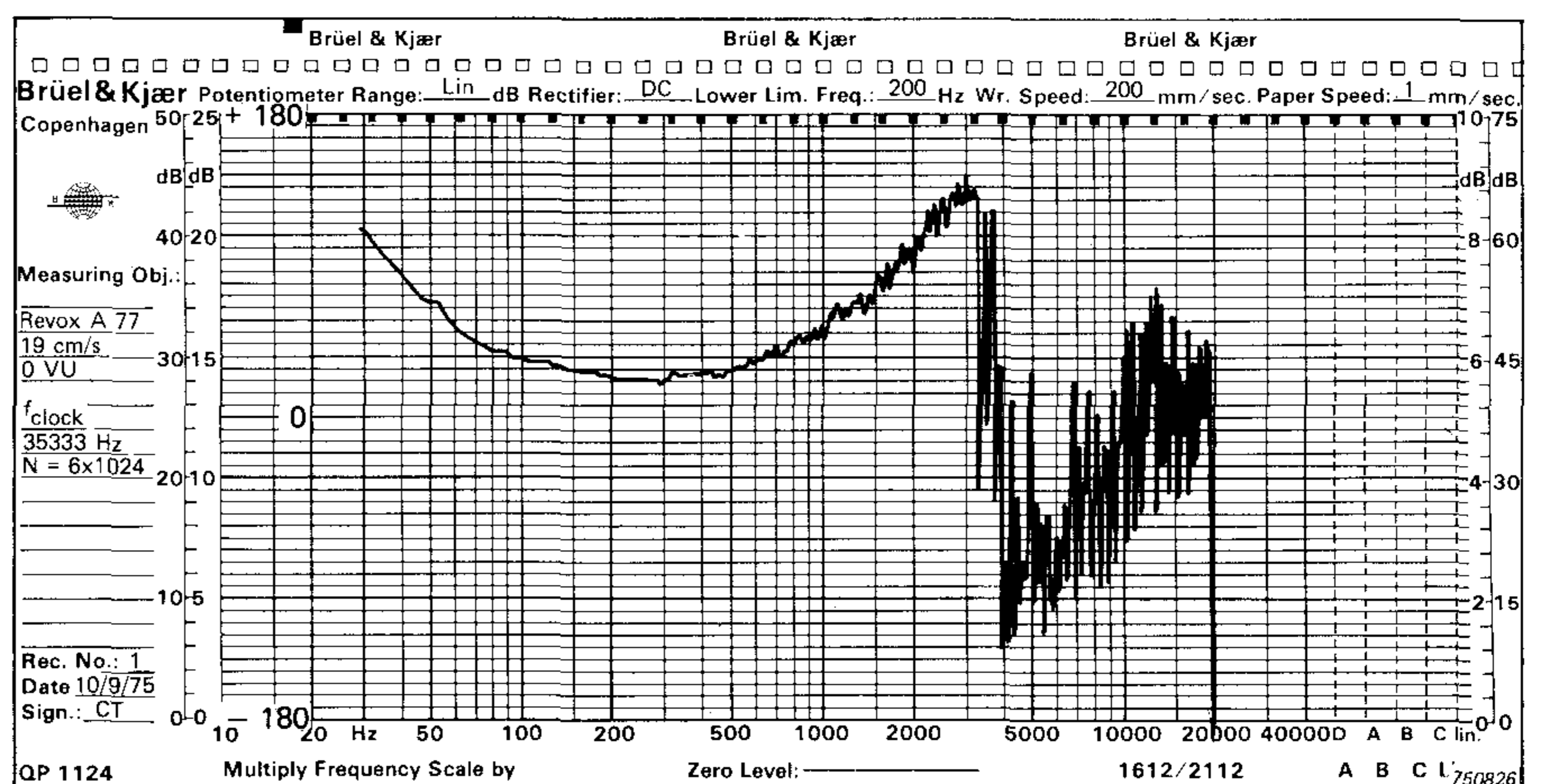

Fig.10. Tape recorder phase measurements using an improperly adjusted clock frequency for the Phase Delay Unit

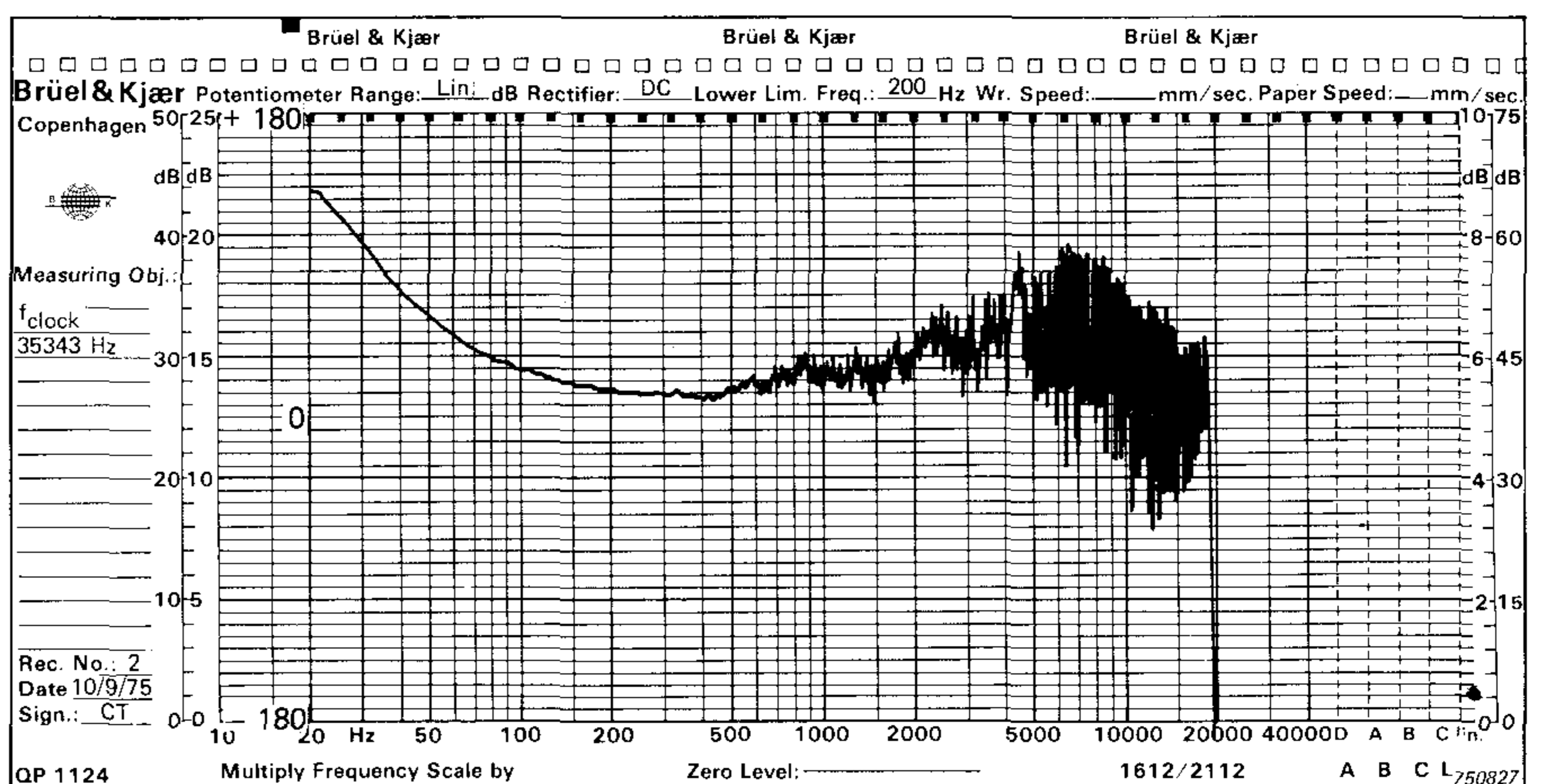

Fig.11. Tape recorder phase measurements using properly adjusted clock frequency

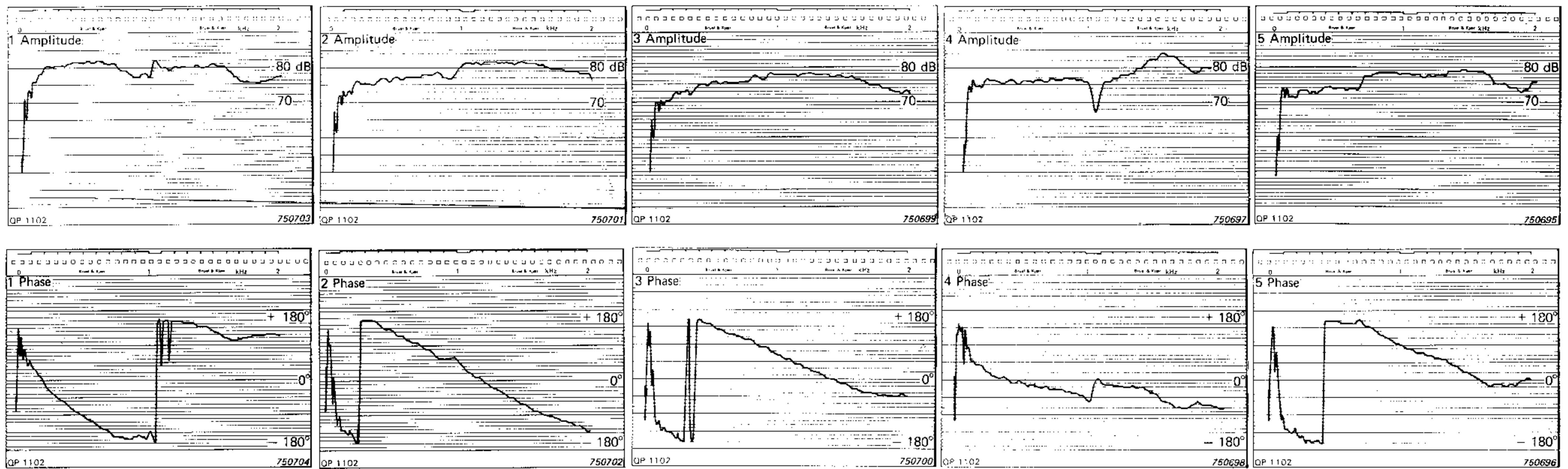

Fig.12. Examples of different amplitude and phase response curves. 0 to 2 kHz

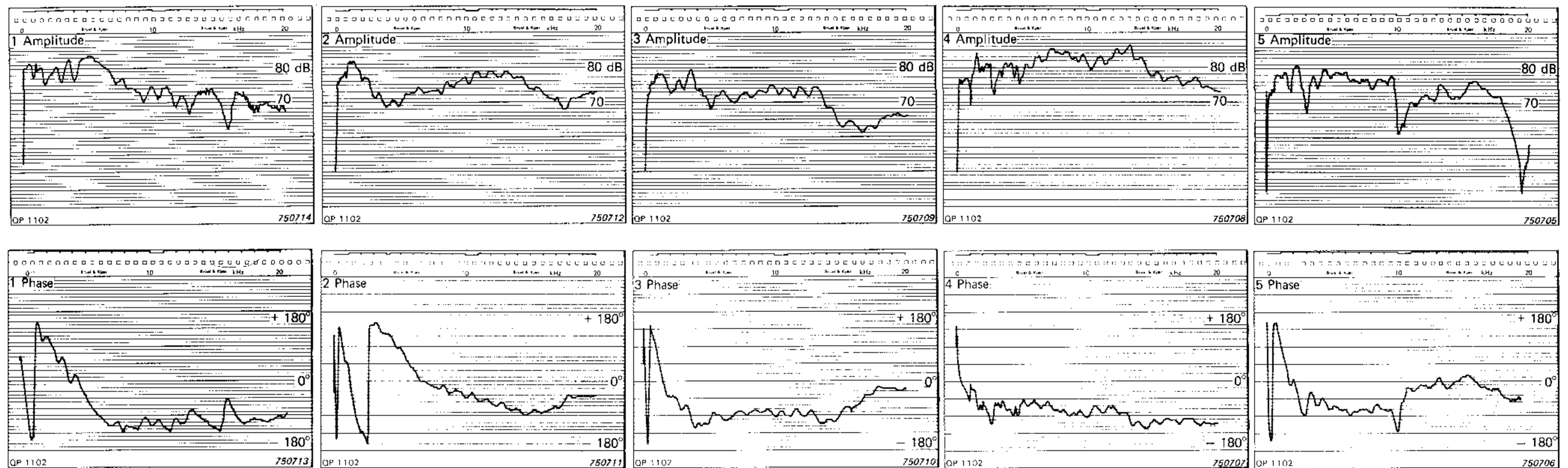

Fig.13. Examples of different amplitude and phase response curves. 0 to 20 kHz

Ideal linear phase response curves are shown in Fig.14.

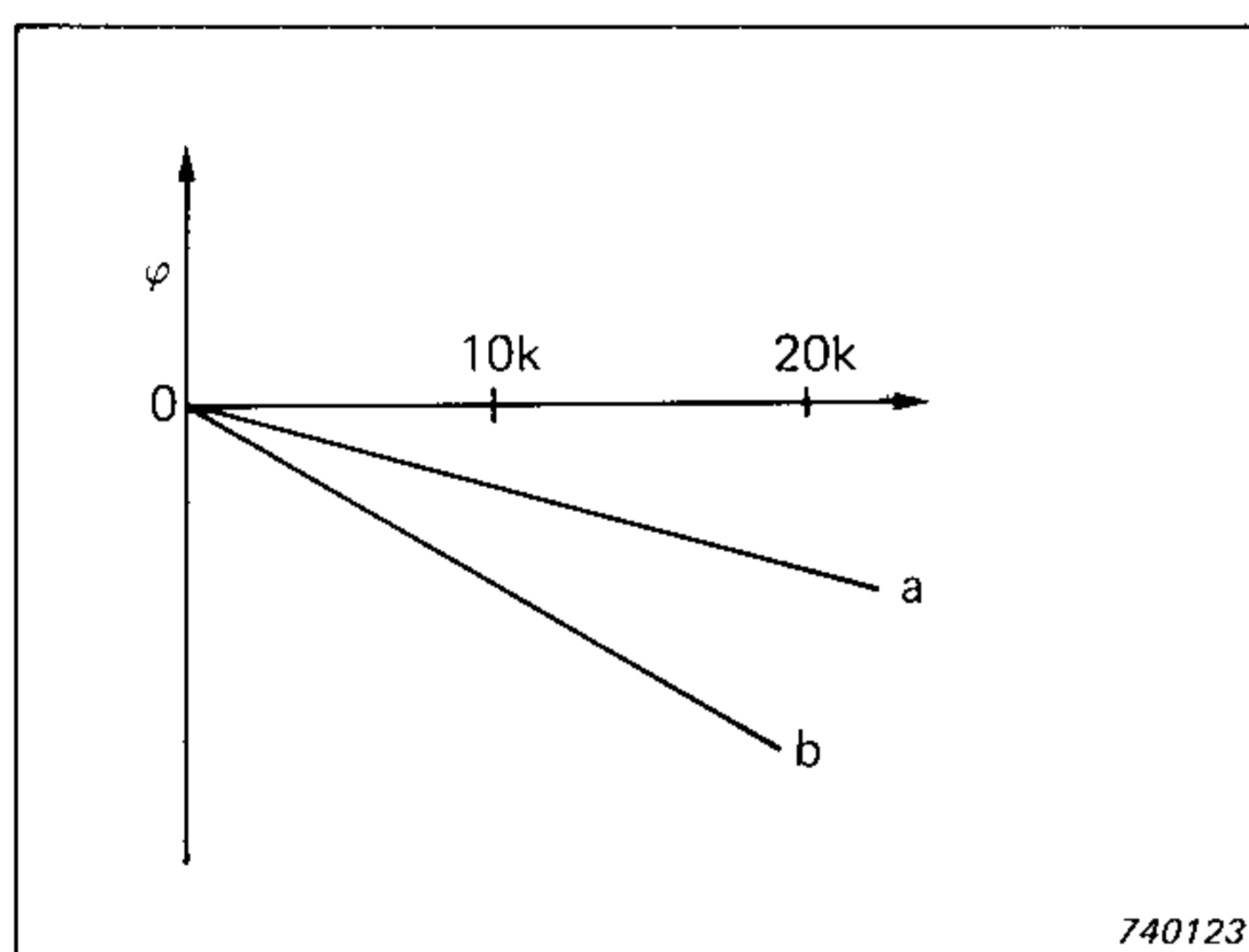

Fig.14. Two different ideal phase response curves; b simply represents a greater delay than a. With no delay, the response will fall on the frequency axis

Electrical Phase measurements

The greatest advantage of the acoustical phase measurement is that it measures the total system including the phase shifts in the units themselves and the cross-over networks as well as the phase shifts due to the relative position of the units.

However, the Phase Meter can of course also be used for electrical phase measurements so that these items can be measured separately.

If there is zero degree phase shift, for all frequencies between electrical input and acoustical output (the f-axis), it means that it takes no time for the produced sound to cover the distance to the measuring point. However since the velocity of sound is not infinite, for a physical system, it will take some time before the resulting sound signal reaches the microphone.

This time corresponds to a constantly decreasing phase shift for increasing frequency. Therefore any straight line through the origin (0,0) represents a perfect phase response.

However, such a line represents only a constant time delay for all frequencies and therefore no time distortion and (with Fig.2 in mind) no transient distortion. The difference between curves a and b is only the slope angle and therefore only a consideration of time. The two curves could represent measurement of a perfect system at two different distances.

This can also be expressed in the formula for group delay:

$$t_D = - \frac{d\phi}{d\omega}$$

where t_D is the time it takes the information to travel the distance, ϕ is the phase and ω the angular frequency $2\pi f$.

Since the difference between curves a and b is only a question of time, it is seen that the influence of the Phase Delay Unit 6202, which also introduces a constant time delay, is exactly the same. What happens using the Phase Delay Unit then is actually a rotation of the plane around the origin (0,0). Therefore, curves a and b could also represent results of measurements on an ideal system measured with two different positions on the 6202.

The Phase Delay Unit is in practice adjusted so that the resulting slope is as flat as possible.

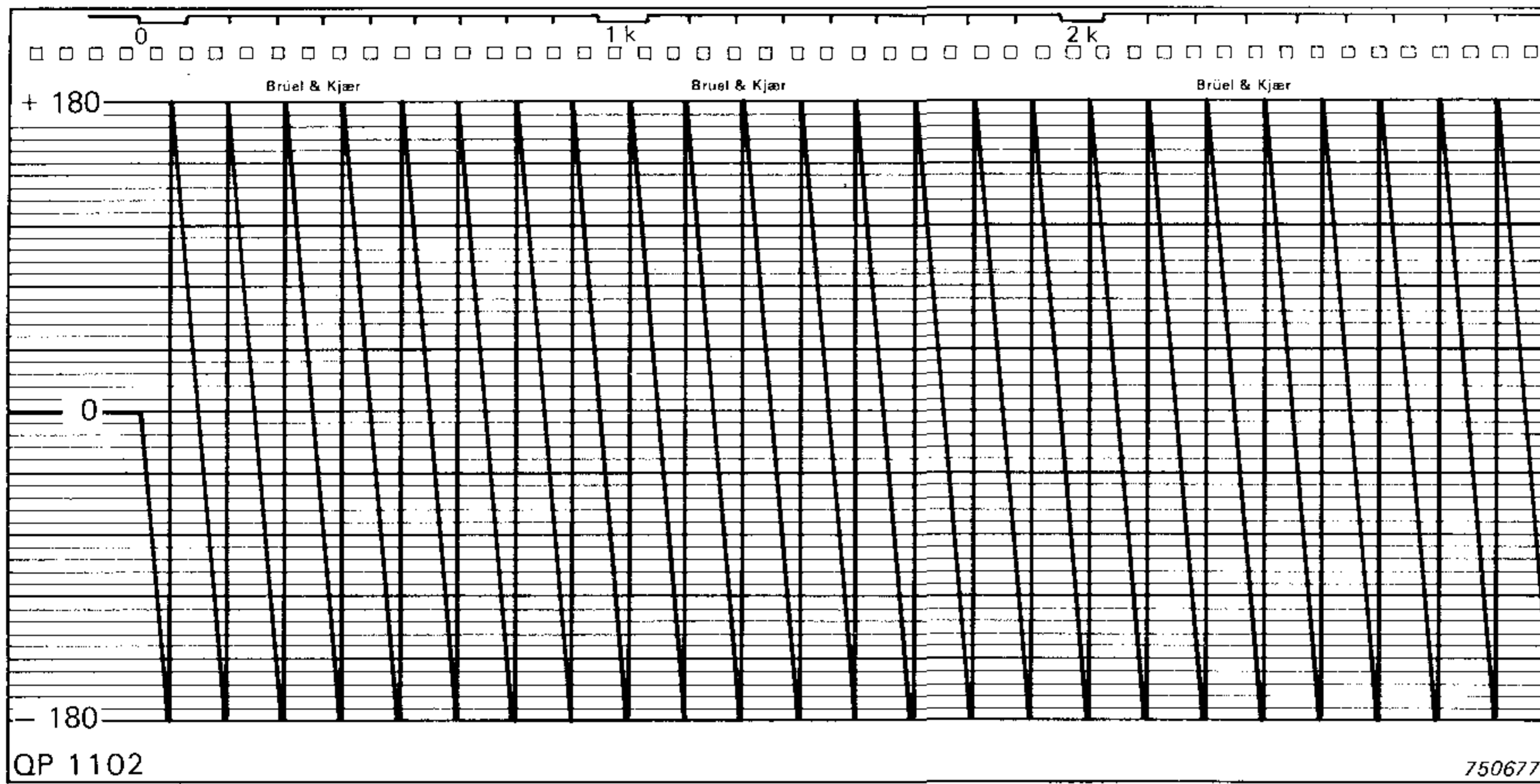

Fig. 15. Typical phase response when measured without the Phase Delay Unit

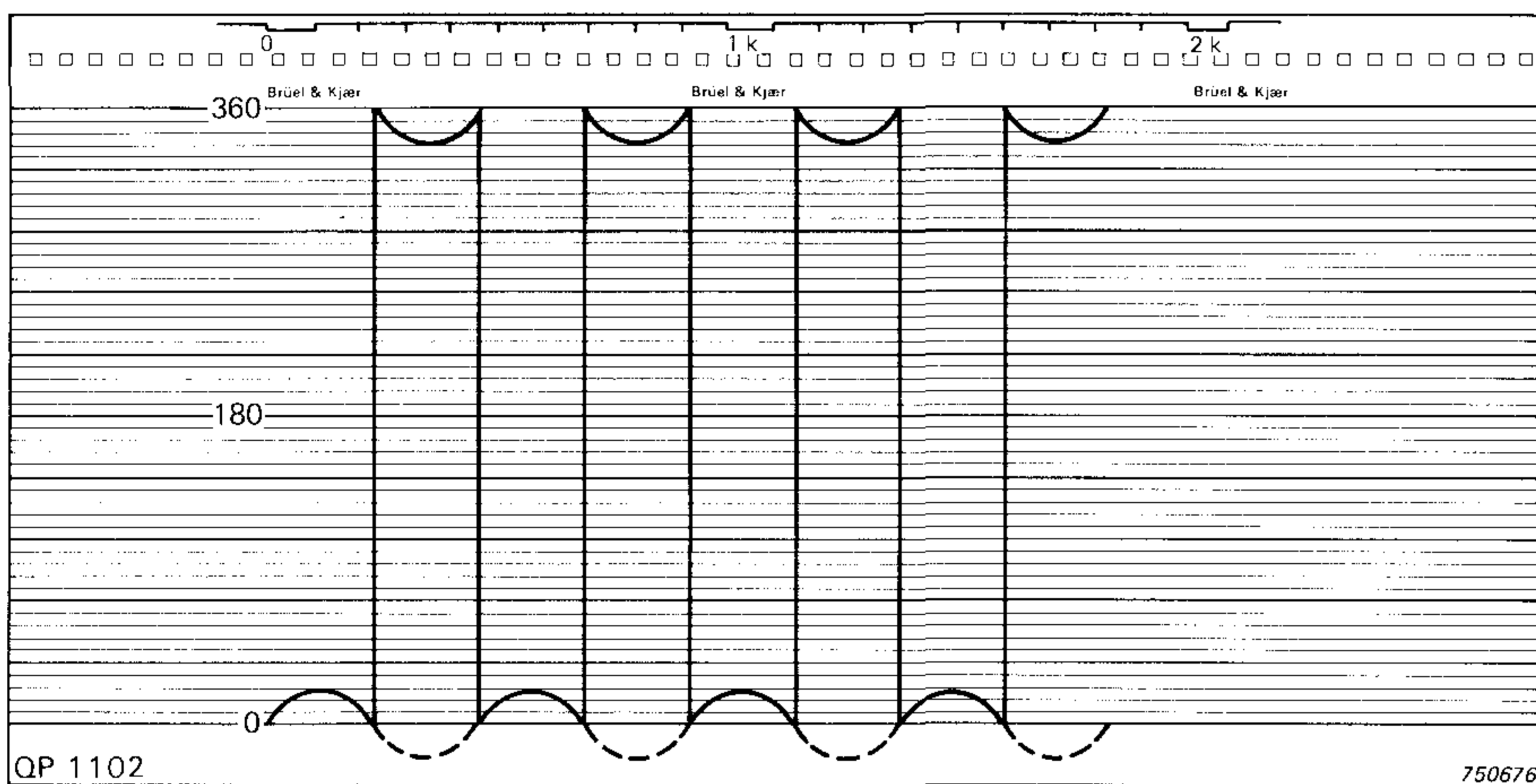

Fig. 16. When the reference is at the bottom line, a phase shift around 0° will shift between just above 0° to just below 360° . By use of one of the slope switches, the 0° reference can be moved to the middle of the paper

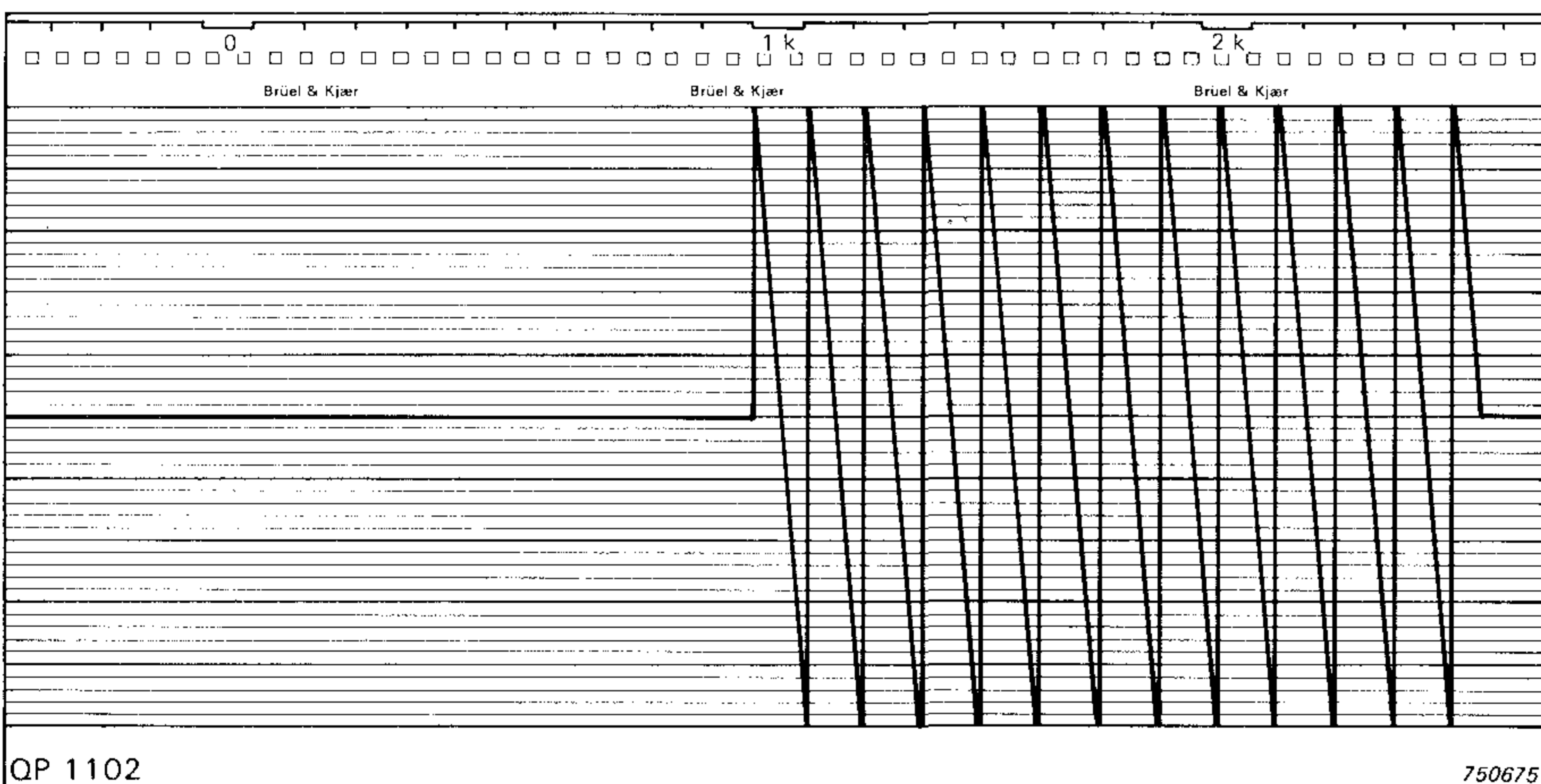

Fig. 17. A two-way loudspeaker system with delay adjusted for the bass speaker

Since the only thing the Phase Delay Unit does is to change the slope, it might seem that the measurement could be performed totally without the Phase Delay Unit. This is true, but very inconvenient in practice, because the slope is much too steep. The resulting curve without the 6202 would look like Fig. 15.

Actually this curve could be used if it was sliced up at the shifting points from -180° to $+180^\circ$ and then put together to make one straight and continuous downward sloping curve. This, however, is very difficult, and the result would still be difficult to interpret due to the extremely steep slope.

From Fig. 15 it is also seen that the instrument automatically shifts from -180° to $+180^\circ$ when the phase passes this value.

Often, phase is plotted in the range 0 to 360° but this may give an inconvenient drawing when the measurement result lies close to 0° . This situation is illustrated in Fig. 16.

If the measurement results are around 0° , the pen on the level recorder will fall just above the bottom line when phase is a little above 0° , but it will shift to a little below the top line when phase passes just below 0° . This recording is correct but it is not very practical and therefore one of the slope switches on the Phase Meter should be used. This will introduce a 180° phase shift in one of the channels and thereby move the 0° line to the middle of the paper. This gives a practical and smooth recording.

When phase response curves are to be interpreted, the ideal is a straight line passing through the origin ($0,0$). The slope is not important but it should be adjusted by use of the Phase Delay Unit until it is as flat as possible. However, in practice this might be impossible over the full frequency range if the loudspeaker system consists of more than one unit, even though all of them are perfect. This is because the acoustic centres of the units are placed at different distances from the microphone.

In the case of a two speaker system, the Phase Delay unit can be adjusted to give an optimal recording of the bass unit response (Fig. 17) or for the response of the high frequency unit (Fig. 18), but not for both simultaneously. Both recordings are correct. Which one should be preferred depends on which unit is considered as the reference. The slope difference indicates, as will be shown later, the distance which the units should be moved relative to each other axially in order to get one straight line and thereby a perfect system.

A question which often comes up when these subjects are discussed is: It is understandable that the phase response curve should be a straight line, but why should it necessarily go through (0,0). Is a curve like the upper one shown in Fig.19 not perfect. After all, it has a constant slope?

The answer is: no, it is not, as long as d does not equal $p \times \pi$ where p is an integer. This can be seen from the lower curve in Fig.19.

The two curves represent the same situation except for a rotation of the plane indicated by the triangle ABC. This corresponds, as indicated in Fig.14, only to different positions of the microphone or delay settings of the Phase Delay Unit and not to any changes in the measuring object.

Since the lower curve in Fig.19 corresponds to the same situation represented by the upper curve, it can be seen that if the phase response curve does not pass through (0,0) the system will have a constant phase shift d for all frequencies.

If this shift equals $p \times \pi$ it does not matter of course, but in all other cases it will result in errors in the transient reproduction. The worst example where $d = \pi/2 = 90^\circ$ is already shown in Fig.2, where it is indicated that a constant phase shift of 90° for all frequencies makes it impossible to reconstruct the transient.

From this it can be seen that it is just as important that the curve goes through (0,0) as it is for it to be a straight line. Actually the curve itself does not have to go through (0,0) but the asymptote in the important frequency range should. This criterion is the most important reason for using the linear frequency scale. The logarithmic scale cannot be used because it never reaches 0 Hz on the frequency scale, and a phase response which is a straight line on a linear scale will be a curve on a logarithmic scale and hence will be difficult to interpret.

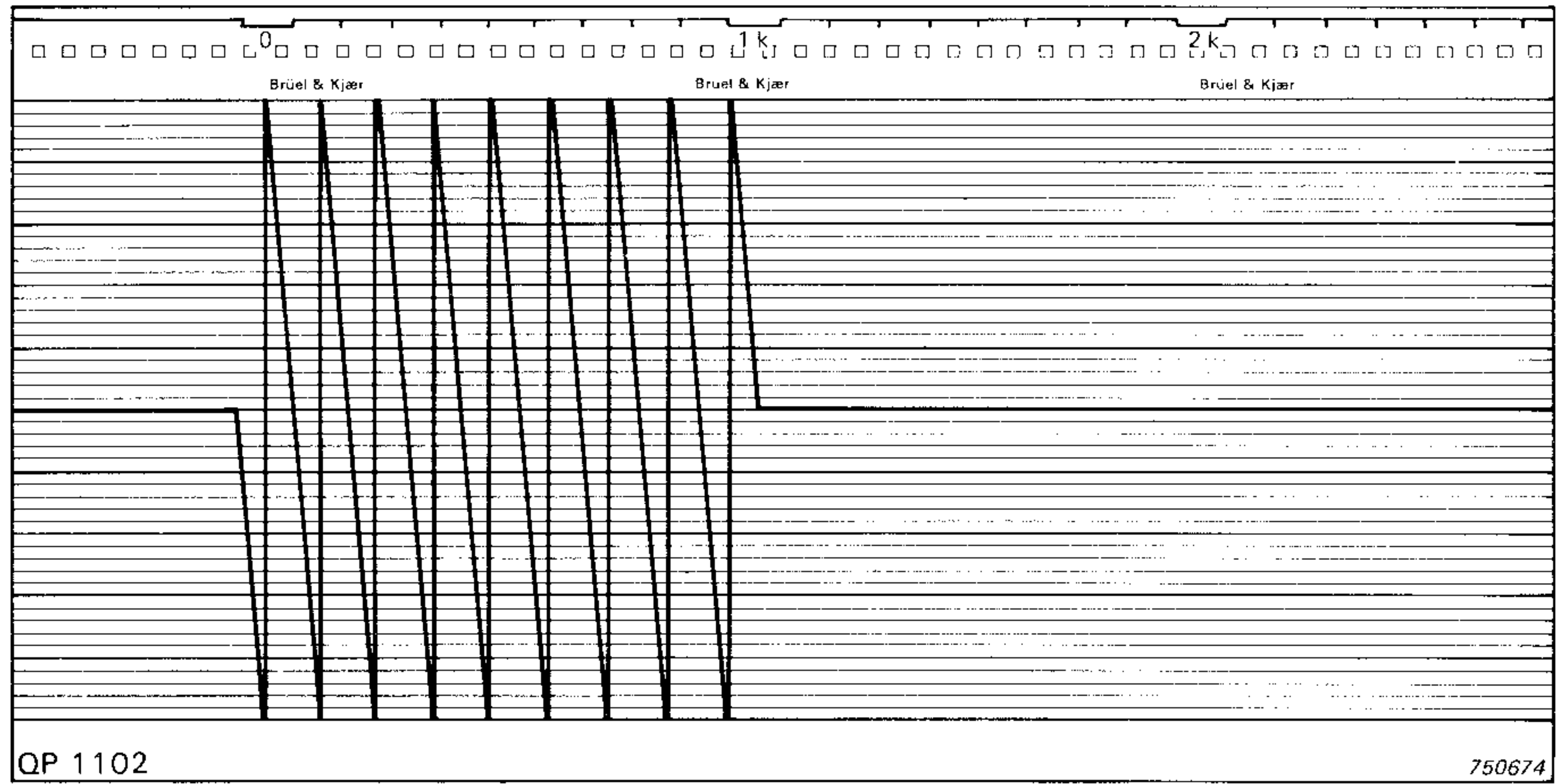

Fig.18. The same loudspeaker system with delay adjusted for the high frequency unit

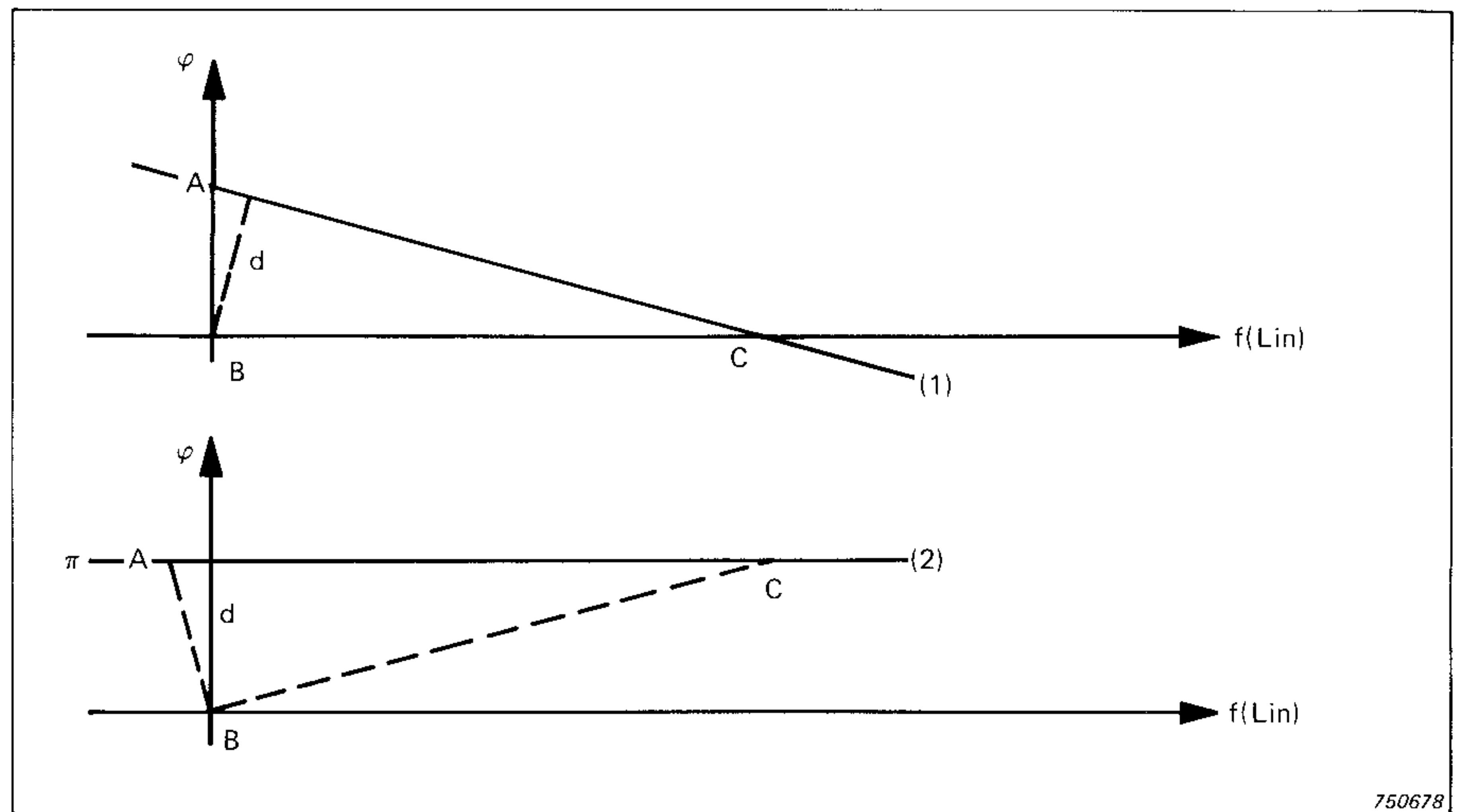

Fig.19. Phase curve (1) represents the same as phase curve (2). Therefore phase curve (1) represents a constant phase shift d for all frequencies

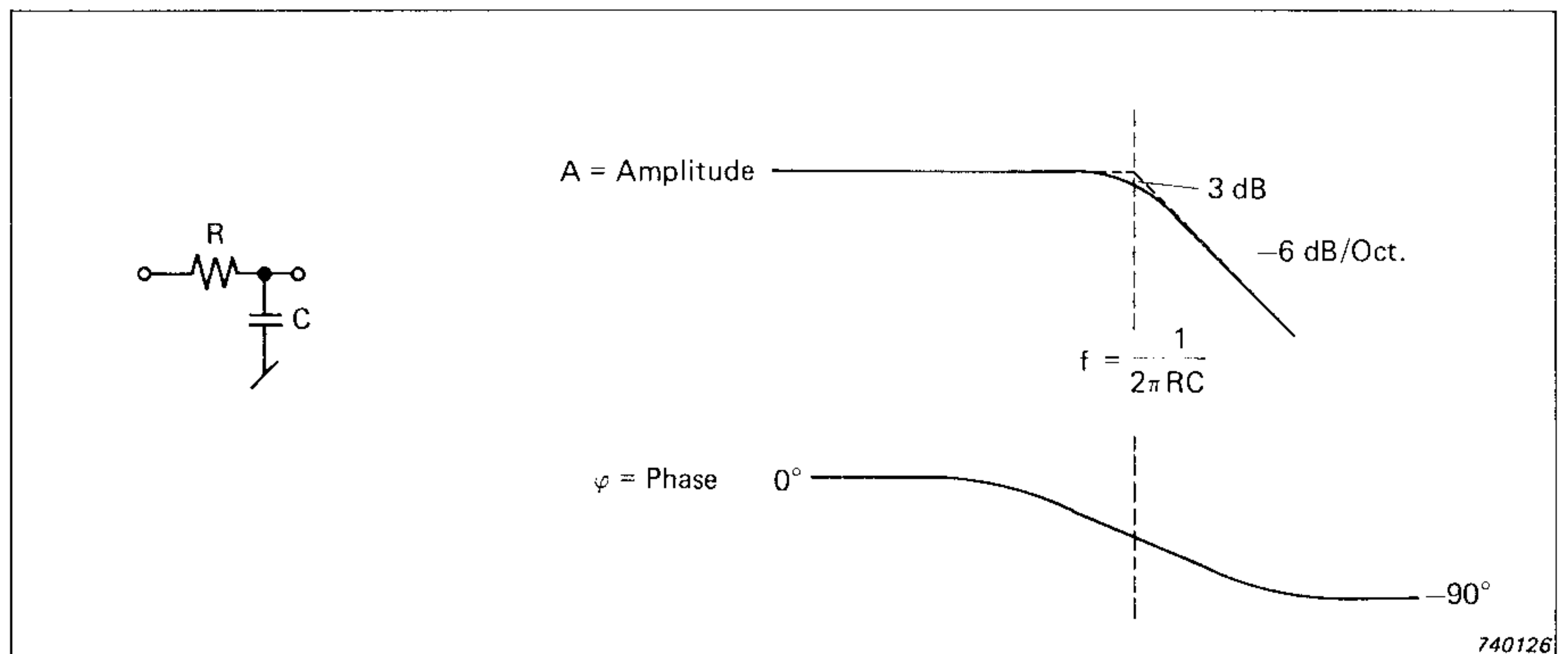

Fig.20. Amplitude and phase response for low-pass filter

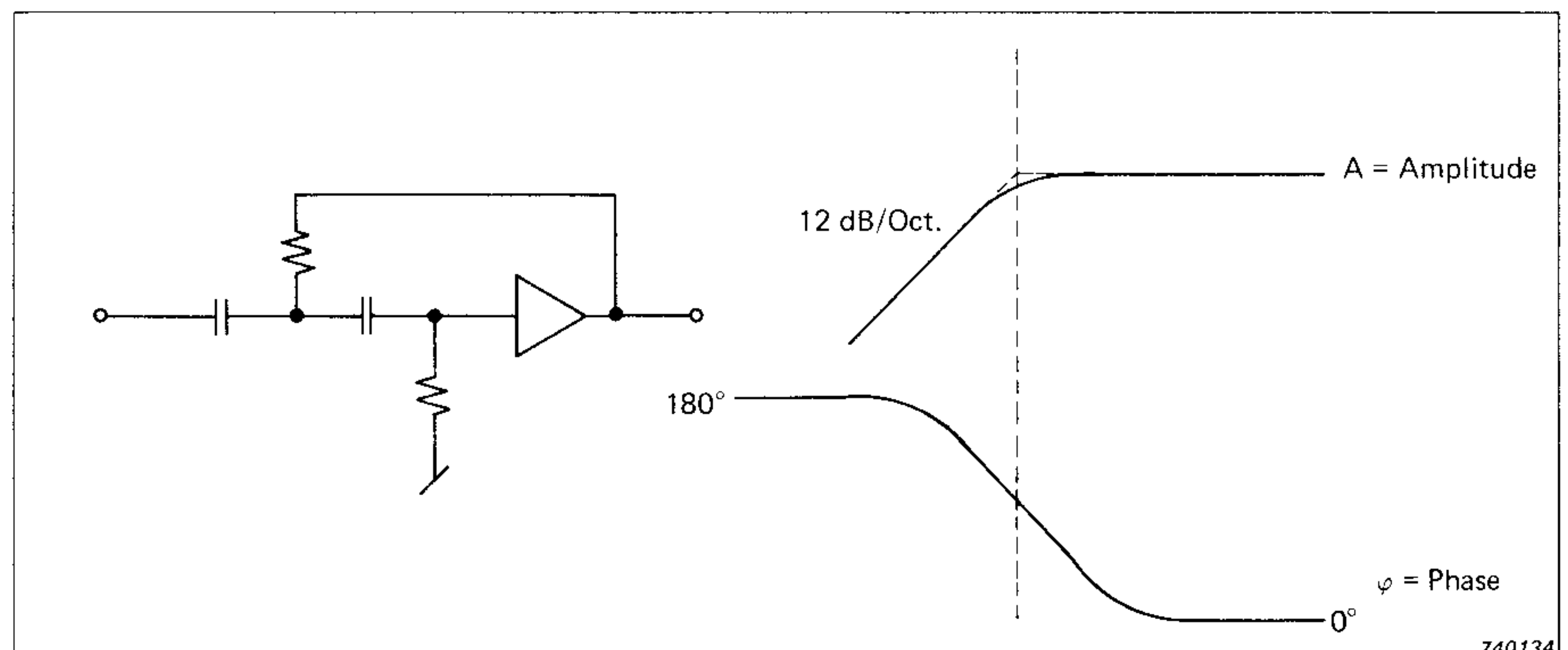

Fig.21. Amplitude and phase response for high-pass filter

Minimum and Non Minimum Phase

In electrical systems, there will normally be a well defined relationship between the amplitude and phase responses — so that if we know the amplitude response it is, in fact, possible to determine the phase response. This is because maximum and minimum in the amplitude response correspond with points of inflection in the phase response and vice versa. An amplitude response decay of 6 dB/octave corresponds with a phase shift of 90°; similarly, 12 dB/octave corresponds with 180°, and so on. Figs. 20 to 28 show typical examples of this relationship.

When amplitude and phase correspond in this way, the system is defined as a minimum phase system. If, in such systems, the amplitude response is flat, then the phase shift will be zero, hence the name.

This is not always valid for loudspeakers. In certain frequency ranges, an improvement in the amplitude response will cause a deterioration in the phase response. In these ranges, the system exhibits the so-called non-minimum phase phenomenon. Unfortunately, it is not possible to predict the ranges in which the system will possess minimum and non-minimum phase phenomena. It is therefore necessary to measure both amplitude and phase response and use these to determine where the system becomes minimum phase, and, hence, where it would pay off to improve the amplitude response.

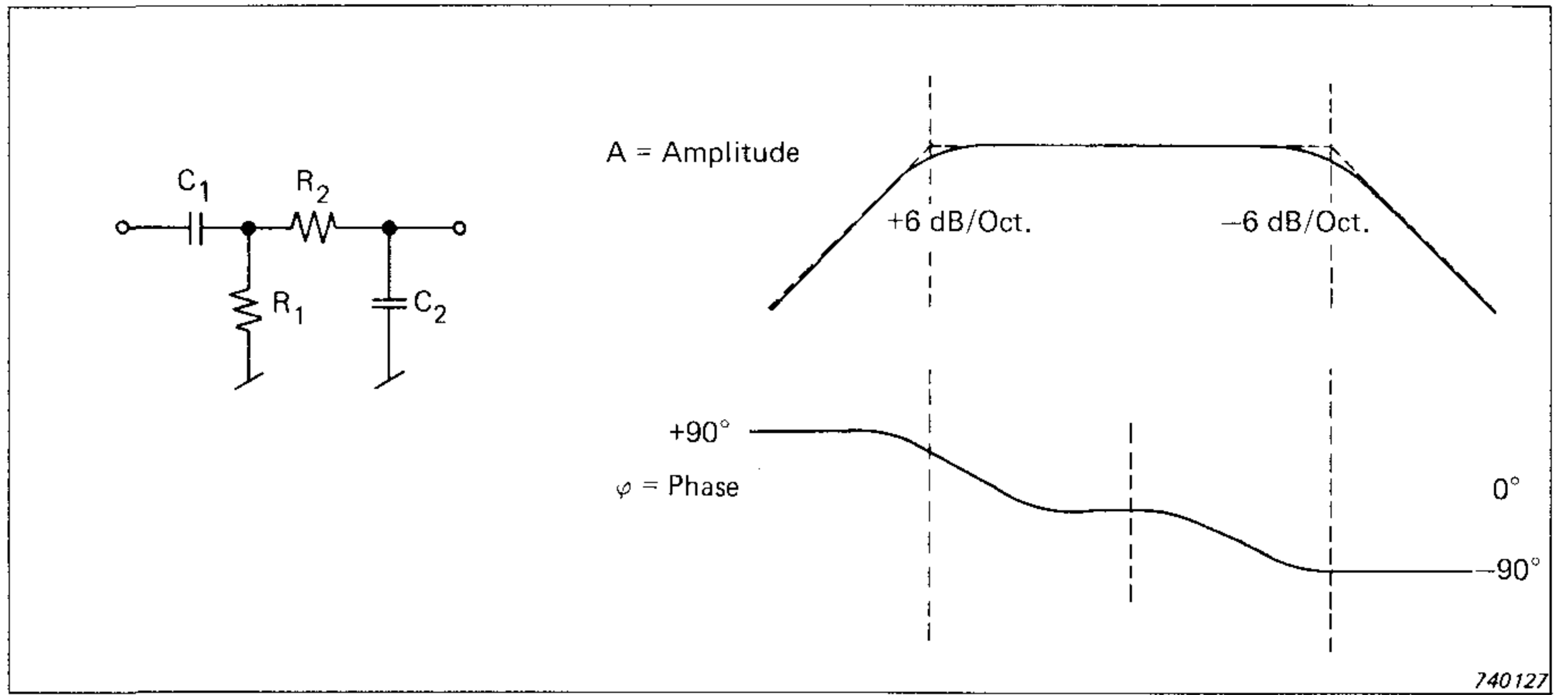

Fig.22. Amplitude and phase response for band-pass filter

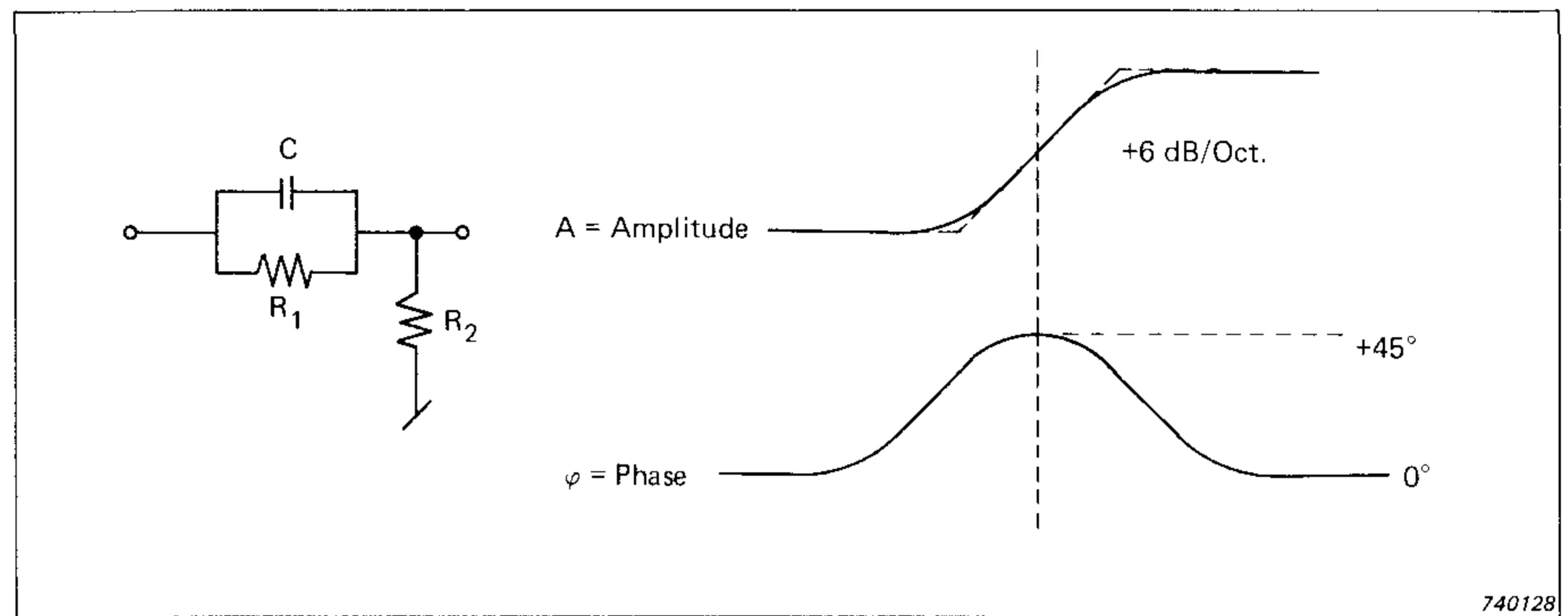

Fig.23. Amplitude and phase response for RC-network

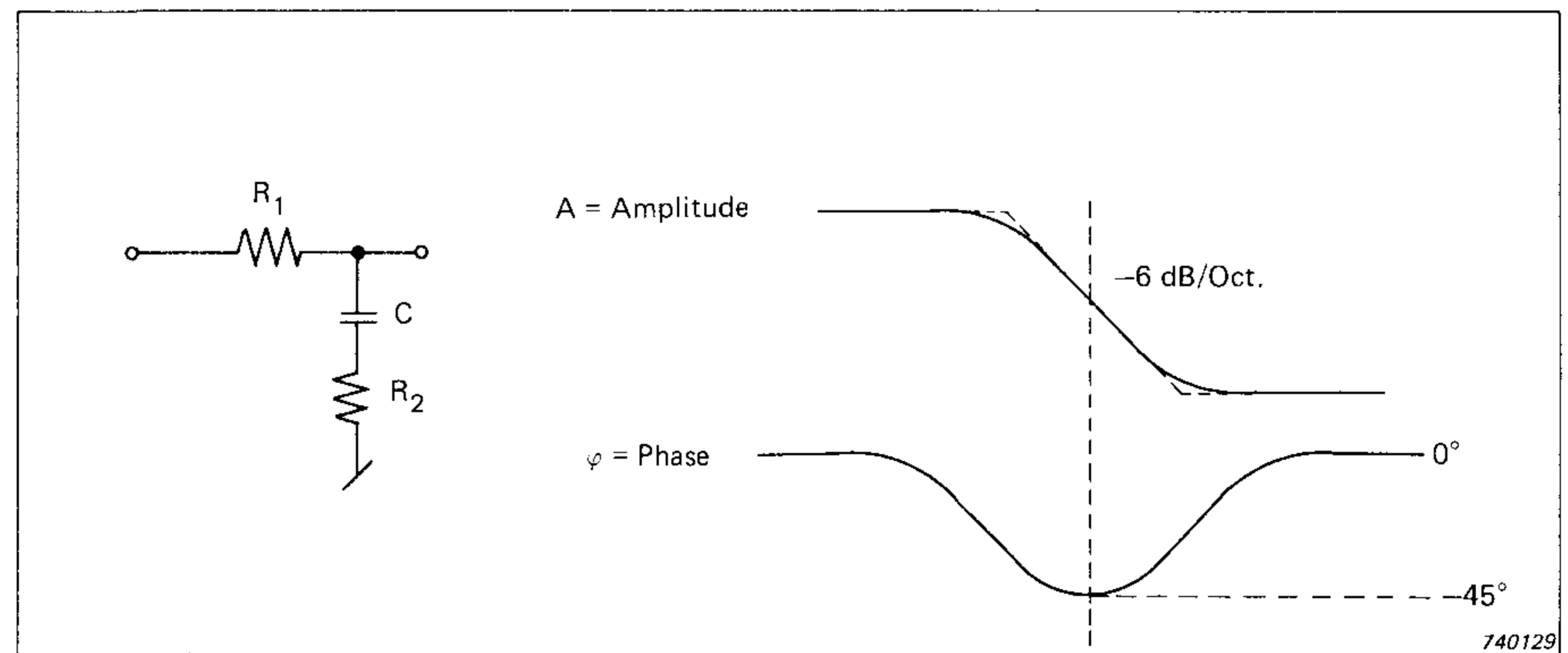

Fig.24. Amplitude and phase response for RC-network

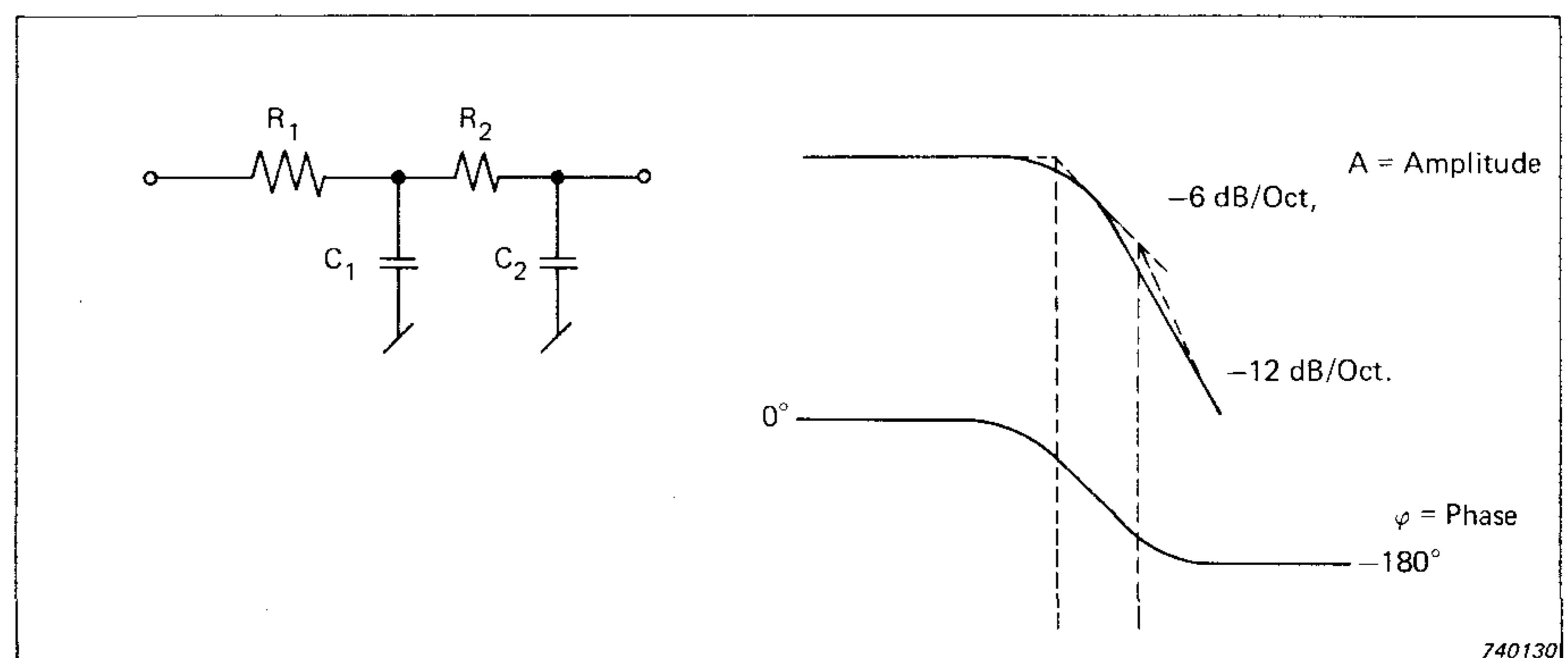

Fig.25. Amplitude and phase response for 1st order and 2nd order low-pass filters

Another feature of the linear sweep in this case is the automatic frequency marking on the top of the recording paper (See, for instance, Figs.5 and 6) because this makes it possible to expand the critical non-minimum phase ranges to almost any desired resolution and accuracy. By using Drive Shaft II on the Level Recorder 2307, the oscillator can be swept very slowly while the paper speed is increased. Frequency marking can thus be obtained every 1 Hz or in some cases even every 0,1 Hz.

Simple Example

Fig.29 shows a typical 3-way loudspeaker system and its related phase response. The acoustic centre of each loudspeaker is indicated by a cross.

To simplify the example, the single units are assumed ideal, i. e. each single unit has a straight phase response curve through (0,0). Also the location of the acoustic centres is assumed independent of frequency. Fig.30 shows by how much the individual units must be repositioned axially in order to get the phase response curves to lie on one continuous line producing, as we have seen earlier, an ideal system. The simplest way of obtaining this in practice is by experiment. Move the individual speakers and perform other measurements until a linear phase response is obtained.

If preferred, it can be calculated by how much the midrange and the tweeter units must be repositioned relative to the bass. As previously mentioned, the different slopes corresponding to the different units are determined. The difference between these slopes represents the time differences and these can be transformed into length differences simply through multiplication with the velocity of sound in the air, i. e.

$$\Delta l_1 = 344 \left(-\frac{\Delta\varphi_3}{\Delta\omega_3} + \frac{\Delta\varphi_1}{\Delta\omega_1} \right)$$

$$\Delta l_2 = 344 \left(-\frac{\Delta\varphi_2}{\Delta\omega_2} + \frac{\Delta\varphi_1}{\Delta\omega_1} \right)$$

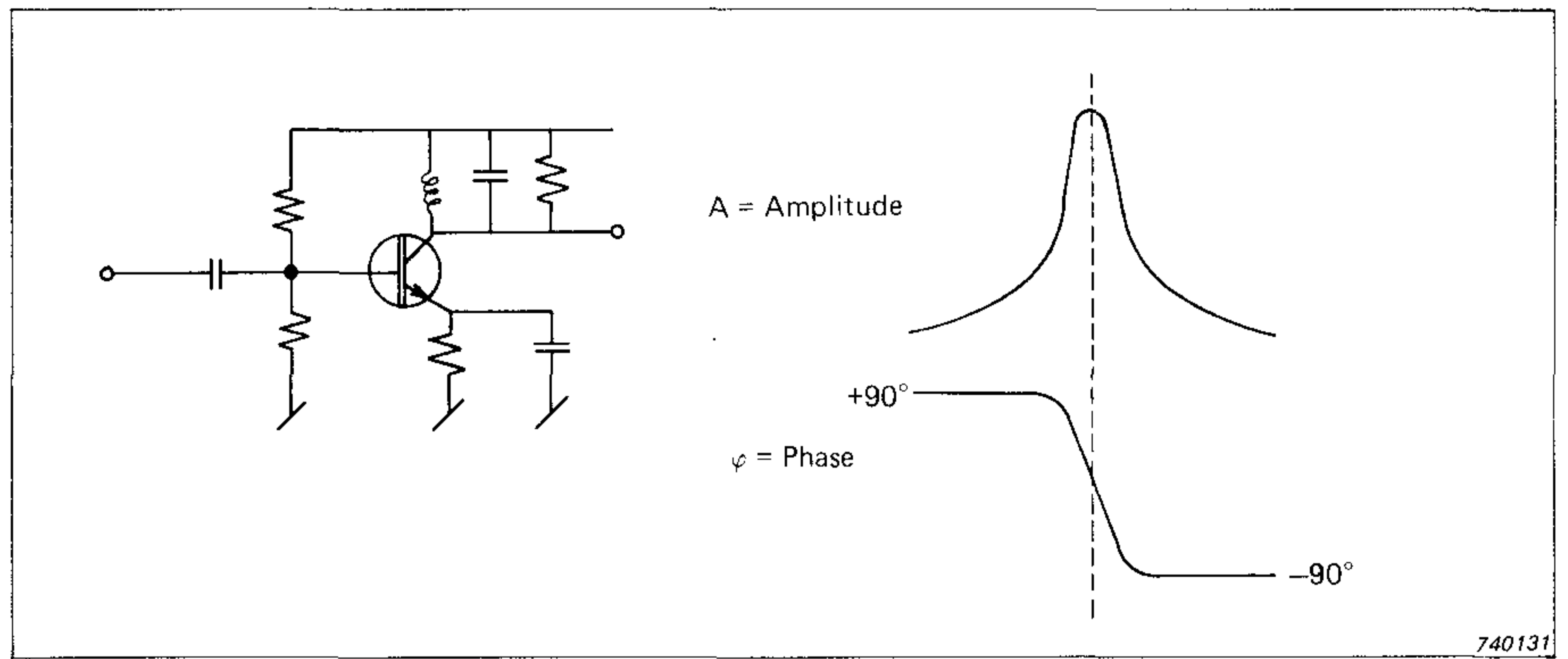

Fig. 26. Amplitude and phase response for band-pass filter

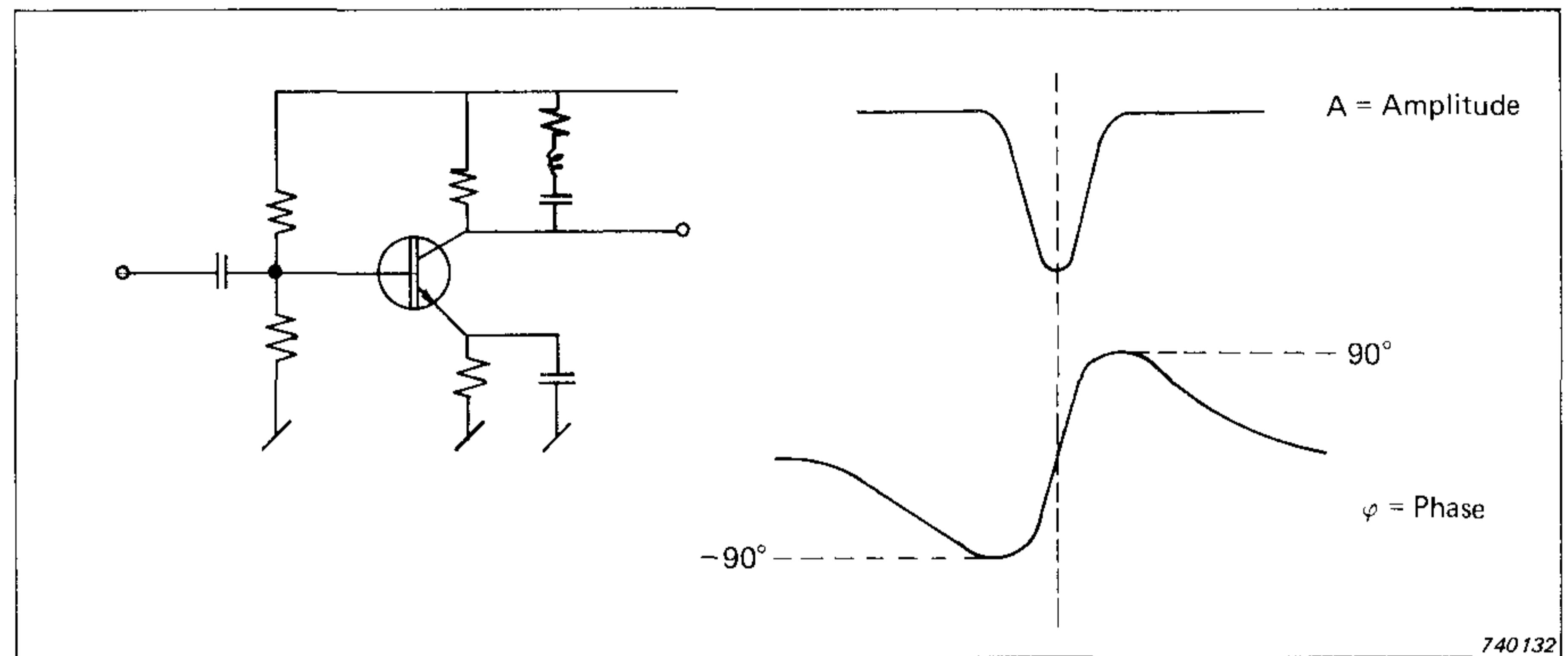

Fig. 27. Amplitude and phase response for band-stop filter

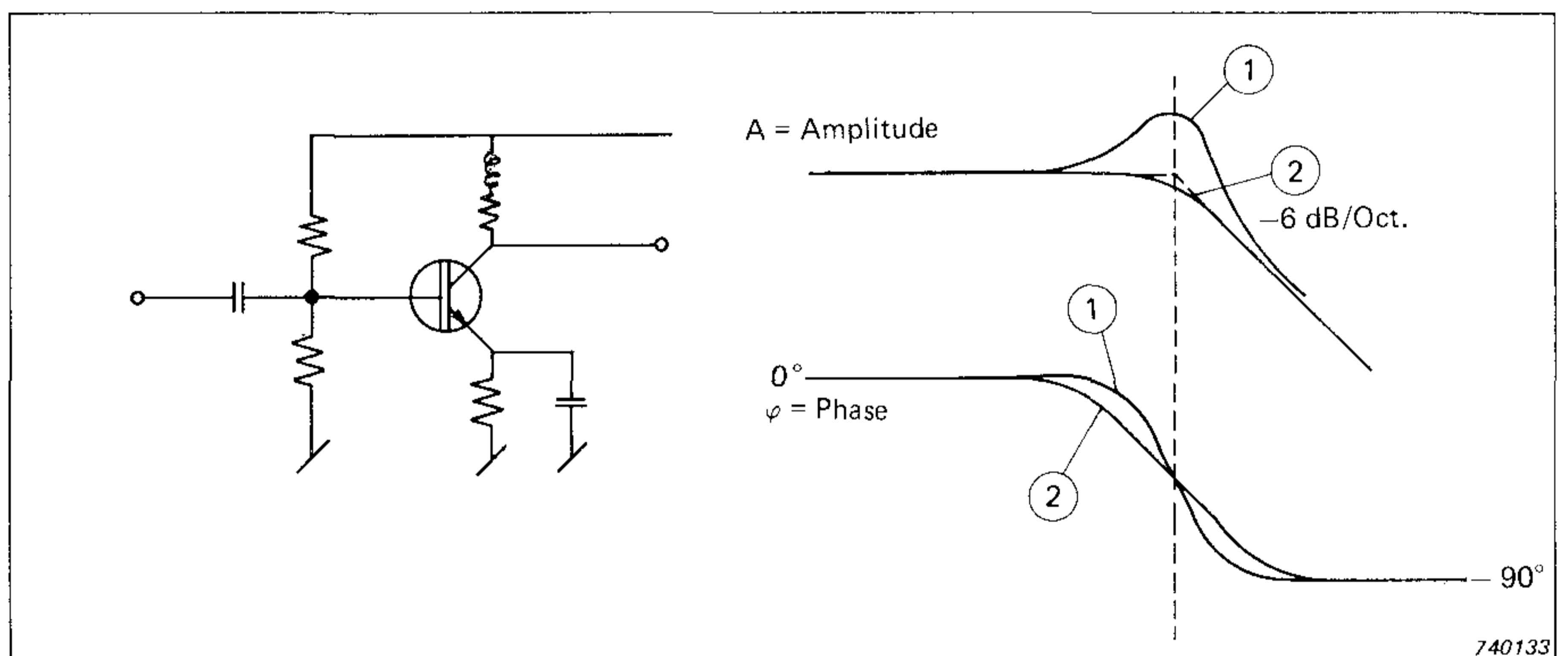

Fig. 28. Amplitude and phase response for low-pass configurations

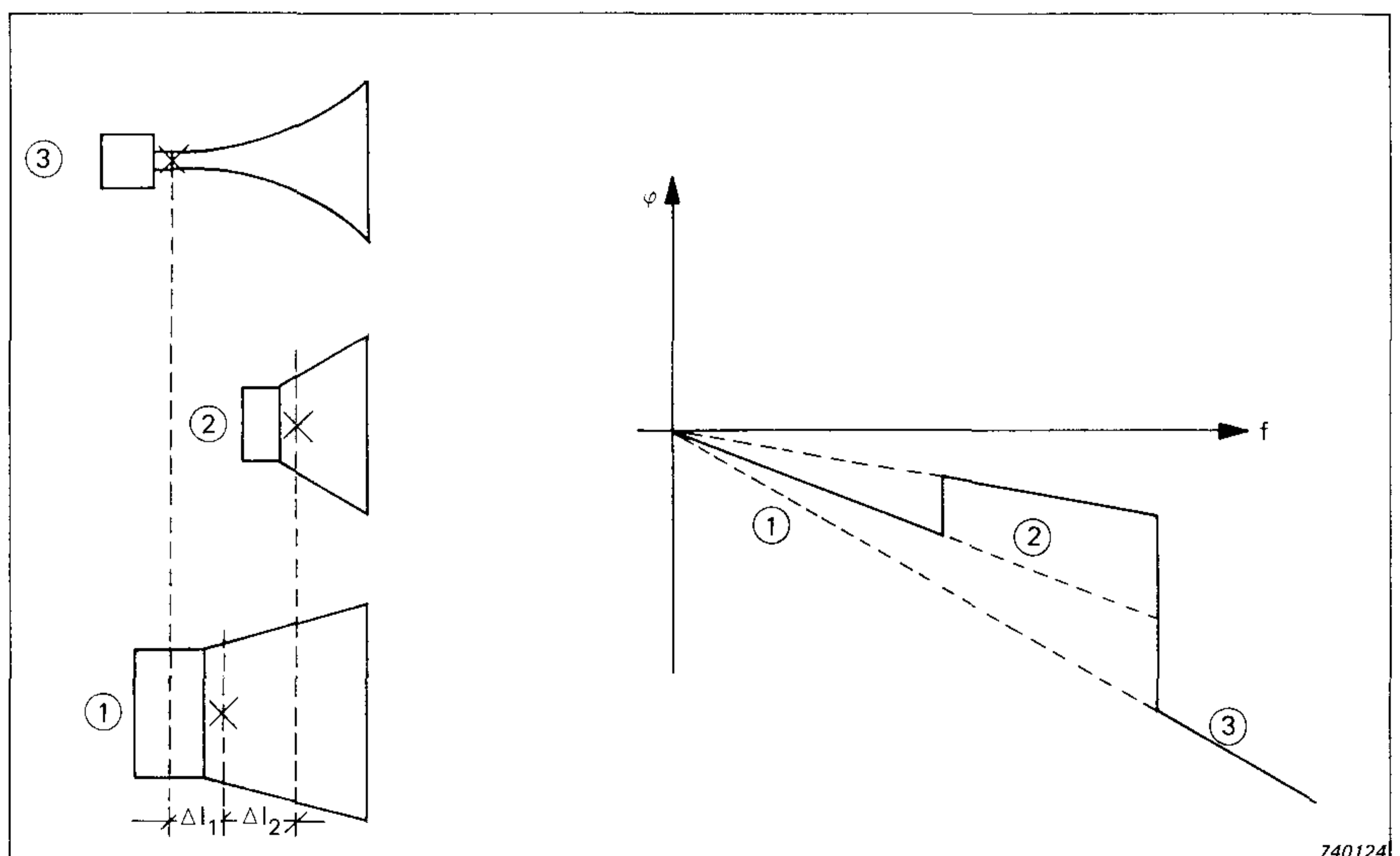

Fig. 29. "Normal" position of speakers on the front plate can cause non-ideal phase response. The crosses indicate the acoustic centres

When these adjustments are made, the phase response curve will be **one** straight line passing through (0,0), as shown in Fig.30, i. e. an ideal system.

A practical example, using the author's own speaker, is shown in Figs.31 and 32. This speaker is in fact speaker H1 from the Application Note 15—067 "Relevant loudspeaker tests in studios, in HI-FI dealer's demo rooms, in the home etc. — using 1/3 octave, pink-weighted random noise".

Fig.31 shows the phase curve as it is with both the bass and mid-range speakers mounted on the frontplate while Fig.32 shows the phase response curve for the modified system where the midrange speaker is moved 19 cm behind the bass unit. The curve was obtained by experiment but to show the principle, the calculations are also made.

It is important to note that the change in phase response due to repositioning of the individual loudspeakers is much more significant than the phase shift due to a relatively large movement of the listener's head (Fig.33).

Different Types of Loudspeaker Enclosures Introduce Different Amounts of Phase Shift

A practical example of the importance of phase response is given in Fig.34 which shows the curves for the different types of conventional loudspeaker enclosures.

Although the basic theory for these types of enclosures was described in great detail by Beranek (Ref.8), Thiele (Ref.10) and Small (Ref.11), it seems that many design engineers have only considered the amplitude part of the transfer function and ignored the phase response part.

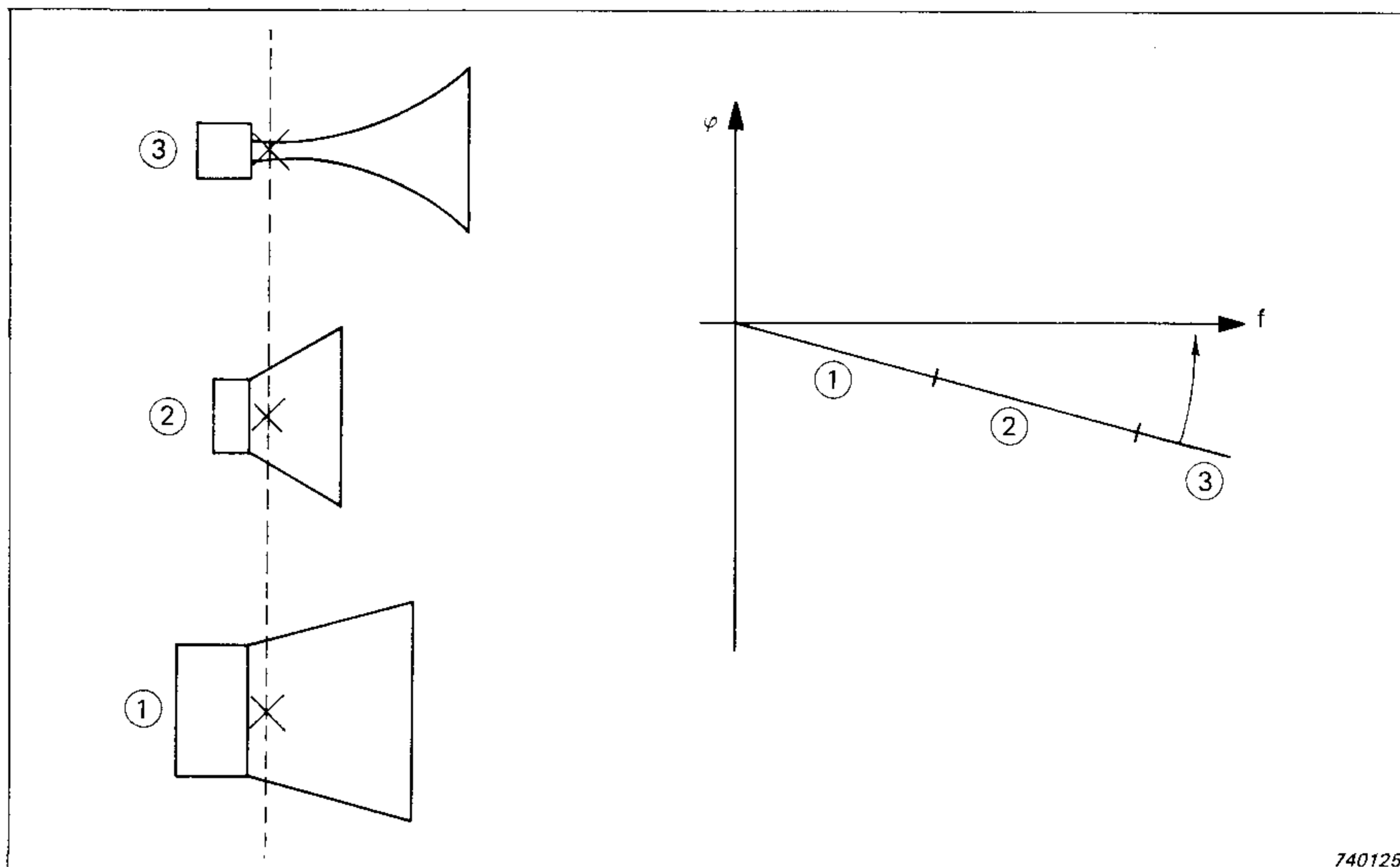

Fig.30. By repositioning the speakers, an ideal phase response can be obtained if the filters and speakers are ideal

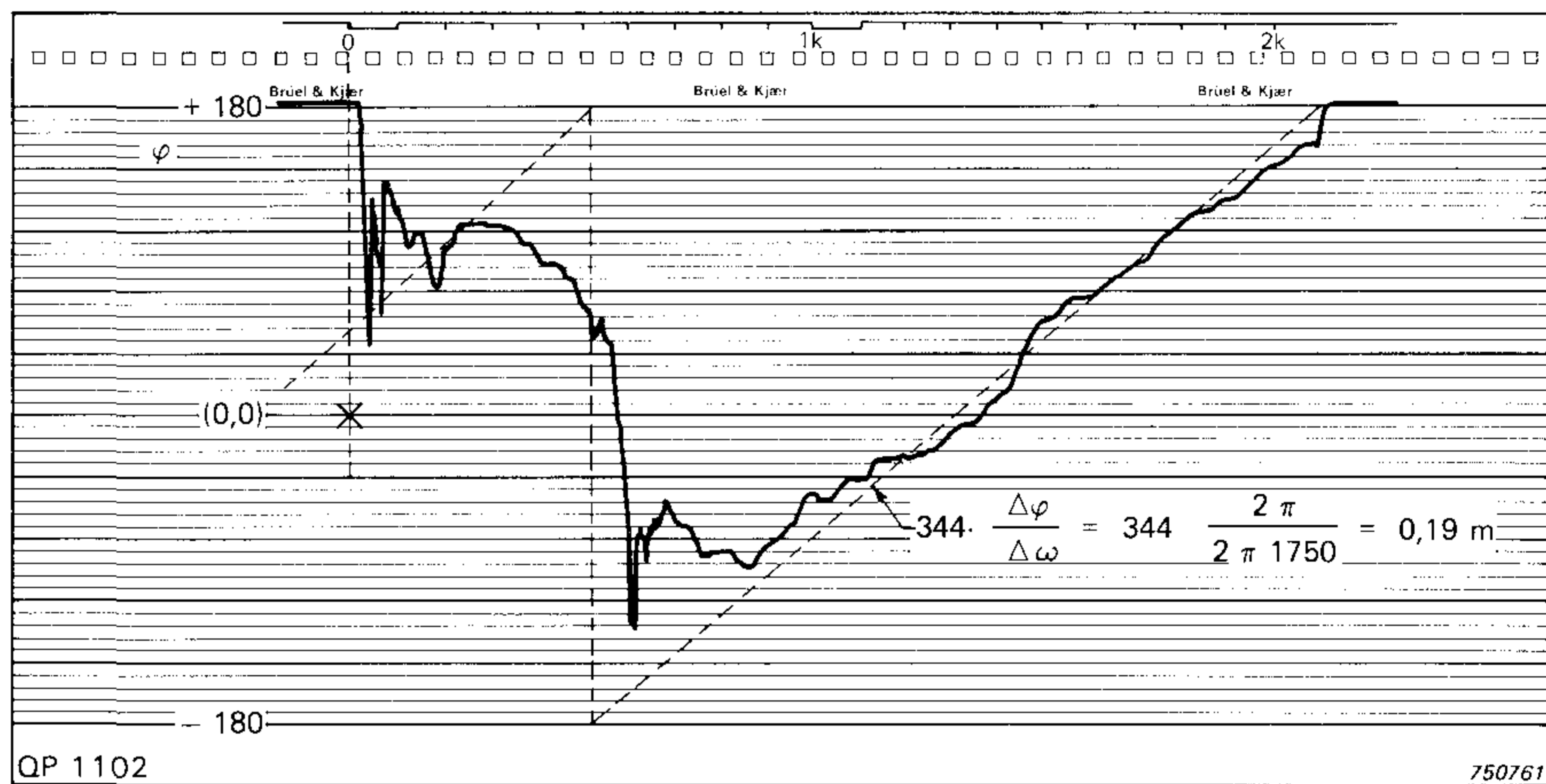

Fig.31. Phase response for loudspeaker system H1 (0 to 2 kHz) with the speakers mounted on the front plate

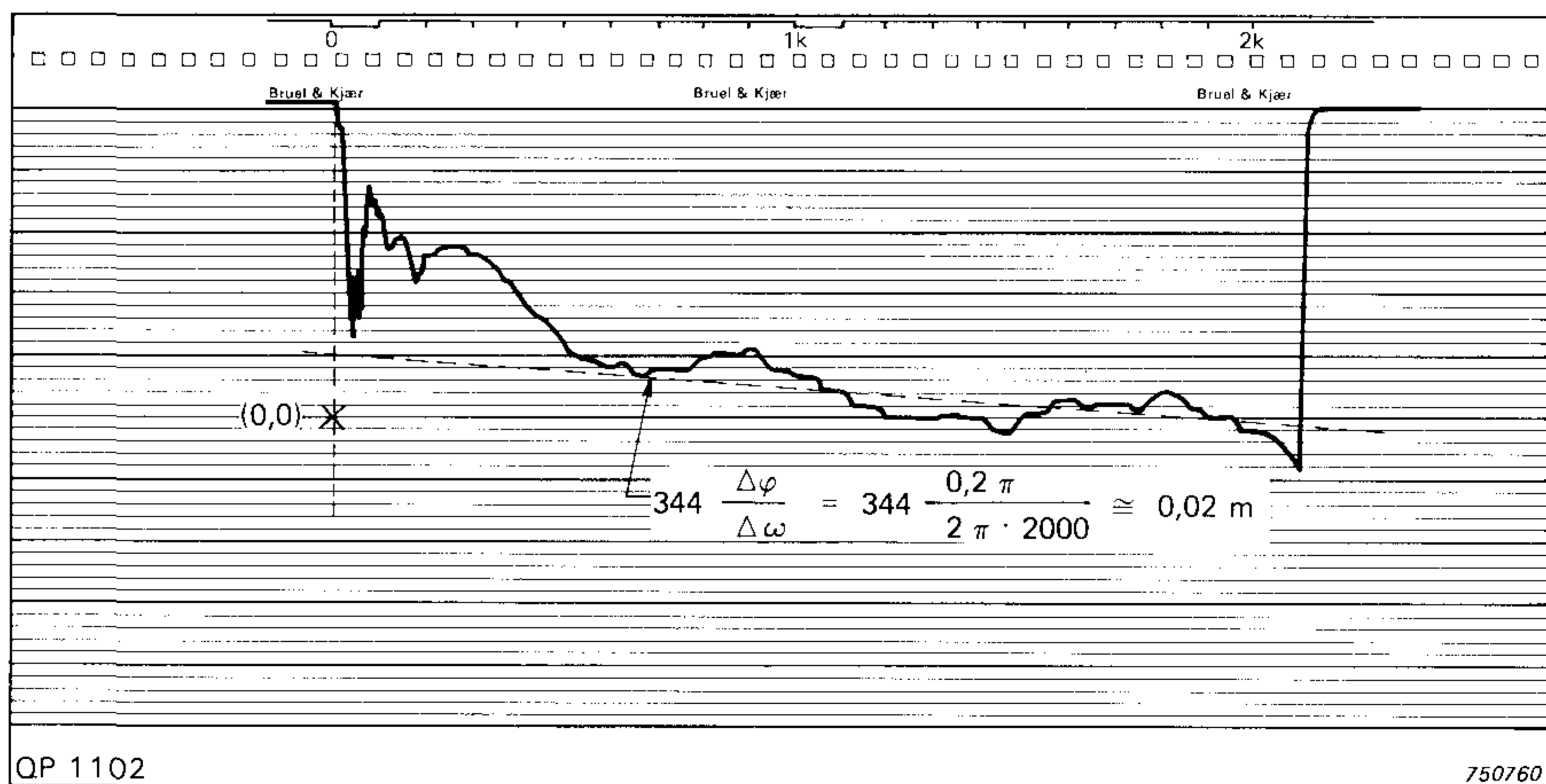

Fig.32. Phase response of the compensated system with the midrange speaker positioned 19 cm behind the bass speaker

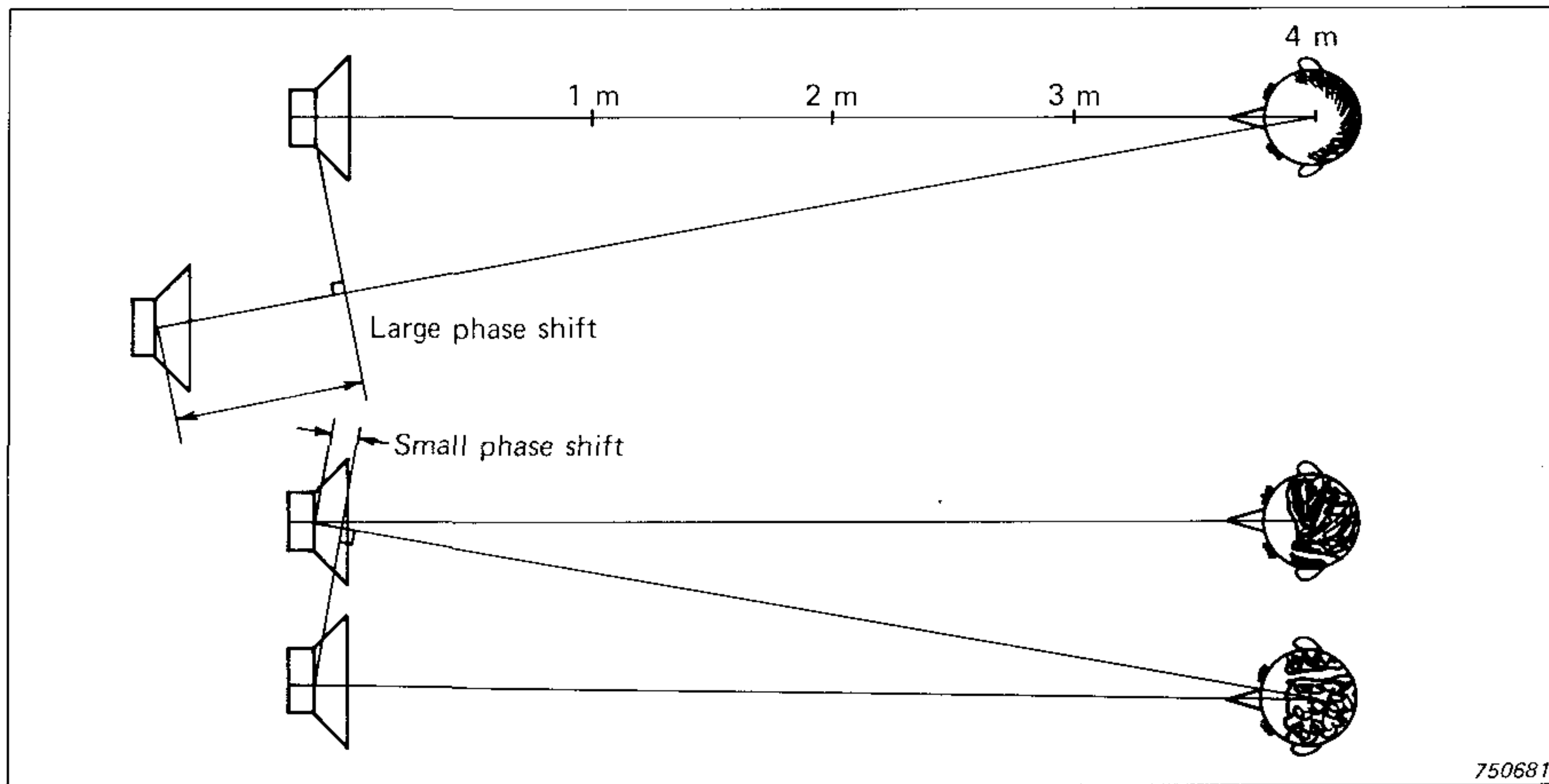

Fig.33. Axial movement of the speakers introduces considerably more phase shift than even greater movements of the listener away from the axis

audible quality. This is one reason why the frequency range of the total Hi-Fi system should be wider than the conventional audio range of 20 Hz to 20 kHz.

For example, there is a clear audible difference between two Brüel & Kjær Condenser Microphones which both have flat amplitude responses in the audible range but have different phase characteristics. The one-inch microphone Type 4145 has a flat amplitude response up to 18 kHz but already has 90° phase shift at 10 kHz. These figures correspond roughly to those of most studio condenser microphones currently on the market. However, the half-inch microphone Type 4133

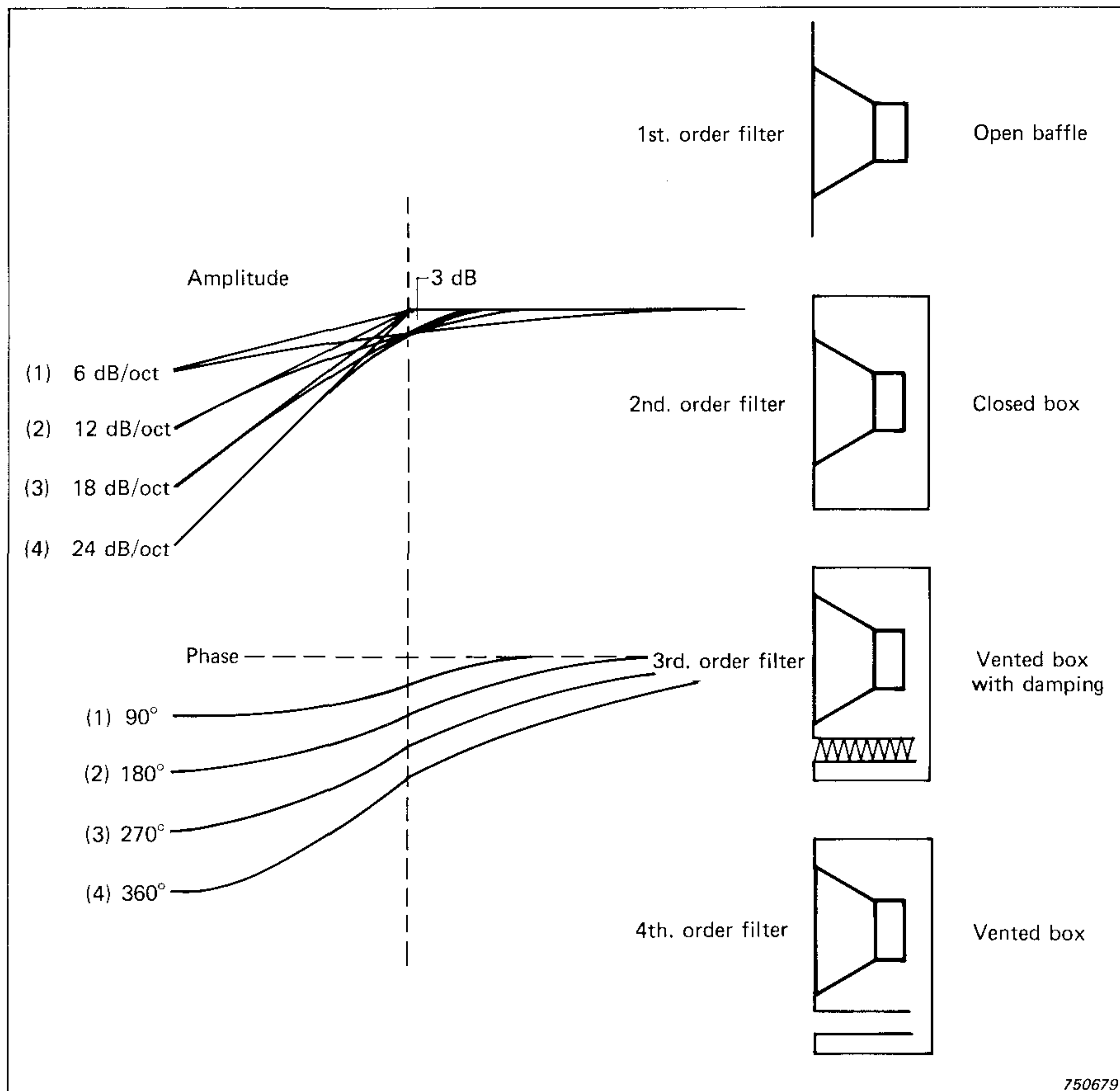

Fig.34. Corresponding amplitude and phase responses of conventional loudspeaker systems. Higher order filters introduce better amplitude response but worsen the phase response

The higher the order of the equivalent filter, the better the amplitude response down to the -3 dB point, but the phase response becomes worse. The vented box will typically end up as a fourth order filter giving a -24 dB/octave roll-off with a corresponding phase shift of 360° which as indicated in Fig.34, creates a considerable phase shift quite high up in the important frequency range. If the -3 dB point is at 50 Hz, a phase shift of approxi-

mately 110° will occur at 100 Hz likewise 60° at 200 Hz and 30° at 400 Hz. Therefore these systems are not very well suited for reproduction of bass transients. On the other hand, the open system will not have such a good amplitude response, but will have a better bass transient performance.

Importance of Frequency Range

High frequency roll-off of the amplitude response curve also effects

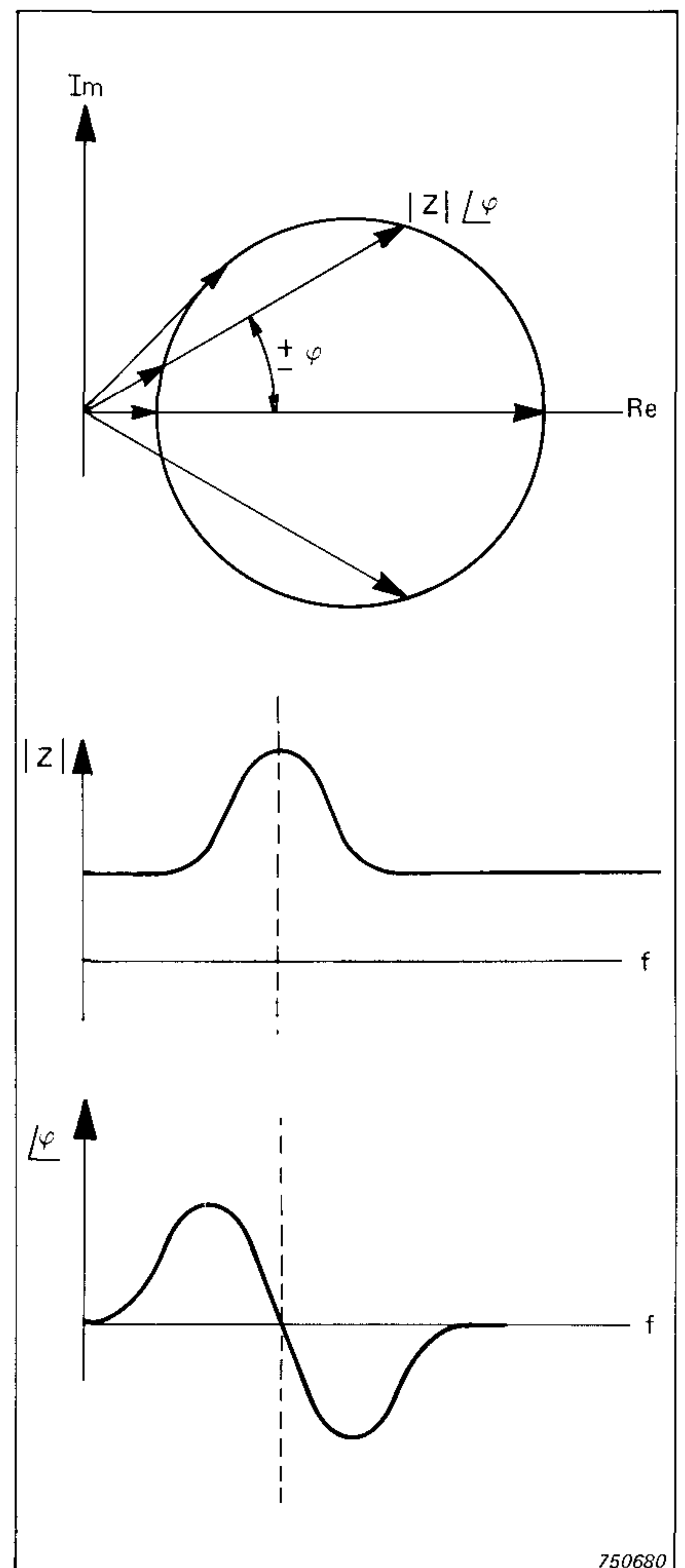

Fig.35. The loudspeaker impedance curve. The impedance can be expressed as the vector. At resonance the amplitude is maximum and the phase is zero. At high frequencies the amplitude is almost the same as at DC and the phase is zero $j\theta(s)$

has flat amplitude response up to 40 kHz which is well above the range of human hearing, and its 90° phase shift occurs first at 25 kHz. A subjective comparison of these two microphones on transient filtered music indicates a more transparent and precise transient reproduction for the half-inch microphone. This, of course, is due to the negligible phase shift of the half-inch microphone in the audible range, which is the result of its wide frequency range.

Complex Impedance

This application note will conclude with one more example where phase until now has not

been considered important — that is in the impedance of a speaker. This is not just resistive but also inductive as can be seen from the loudspeaker impedance curve in the complex plane with the real axis (Re) and the imaginary axis (Im) Fig.35.

The impedance can be described as the vector $|Z| \angle \varphi$ from the origin (0,0) to a point on the circle. The closest point to the origin corresponds to DC where the amplitude $|Z|$ is minimum and the phase shift is zero. When passing around the circle, it is seen, as indicated on the figure, that both $|Z|$ and $\angle \varphi$ increase until the vector is tangent to the cir-

cle. $|Z|$ continues to increase until resonance where it is maximum and resistive. Above resonance, it decreases and ends up with a value close to the DC value.

Impedance can be measured with all B & K oscillators using the compressor circuit to maintain a constant current in the circuit. Then the voltage across the speaker is proportional to the impedance. $\angle \varphi$ can be plotted using the Phase Meter Type 2971. These last examples indicate that amplitude and phase should be seen together, — they are interrelated and not isolated phenomena.

Conclusion

The phase response together with the amplitude response give the complete transfer function which describes the steady state and transient responses of the system. With the Phase Meter and the Phase Delay Unit, it is just as easy to mea-

sure the phase response of a speaker as it is to measure its amplitude response.

If the bass speaker and the mid-range speaker have different slopes in a linear phase response, it

is easy to calculate how much these units should be moved axially with respect to each other to improve the phase response, the transient response, and as a consequence, also the audible quality.

References

- Ref.1. Richard C. Heyser
Loudspeaker Phase Characteristics and Time Delay Distortion: Part 1
January 1969, Part 2 April 1969
Journal of the Audio Engineering Society
- Ref.2. Richard C. Heyser
Determination of Loudspeaker Signal Arrival Times: Part 1 October 71, Part 2 November 71, Part 3 December 71
Journal of the Audio Engineering Society
- Ref.3. E. Rørbæk Madsen and H. Staffeldt
Højttalerundersøgelser: Akademiet for de tekniske videnskaber, Denmark 1972
Short English version presented at the 47th AES Convention 26 — 29 Feb. 1974
- Ref.4. Henning Møller
Relevant loudspeaker tests in studios
- in Hi-Fi dealers' demo rooms, in the home etc., — using 1/3 octave, pink-weighted, random noise
B & K Application Note 17—197
- Ref.5. Henning Møller and Carsten Thomsen
Electroacoustic free-field measurements in ordinary rooms — using gating techniques:
B & K Application Note 17—196
- Ref.6. Carsten Thomsen and Henning Møller
Swept measurements of harmonic, difference frequency and intermodulation distortion
B & K Application Note 15—098
- Ref.7. E. Rørbæk Madsen
Threshold of Phase Detection by Hearing
Audio Engineering Society, Inc.
Paper of the 44th AES Convention Rotterdam 1973.
- Ref.8. L. L. Beranek
Acoustics: McGraw-Hill, New York 1954
- Ref.9. Franklyn F. Kuo
Network analysis and synthesis
John Wiley and Sons, Inc. USA
- Ref.10. A. N. Thiele
Loudspeakers in Vented Boxes
Proc. IREE (Australia) vol. 22 Aug. 1961, republished in AES Journal, May 1971 and June 1971
- Ref.11. Richard H. Small
Vented-Box Loudspeaker Systems
Journal of the Audio Engineering Society, Parts I-III, June 1973 to September 1973
- Ref.12. Henning Møller
Electro Acoustic Measurements
B & K 16—035



... first in Sound and Vibration

Brüel & Kjær

DK-2850 NÆRUM, DENMARK

Telephone: + 45 2 80 05 00

TELEX: 37316 bruca dk